

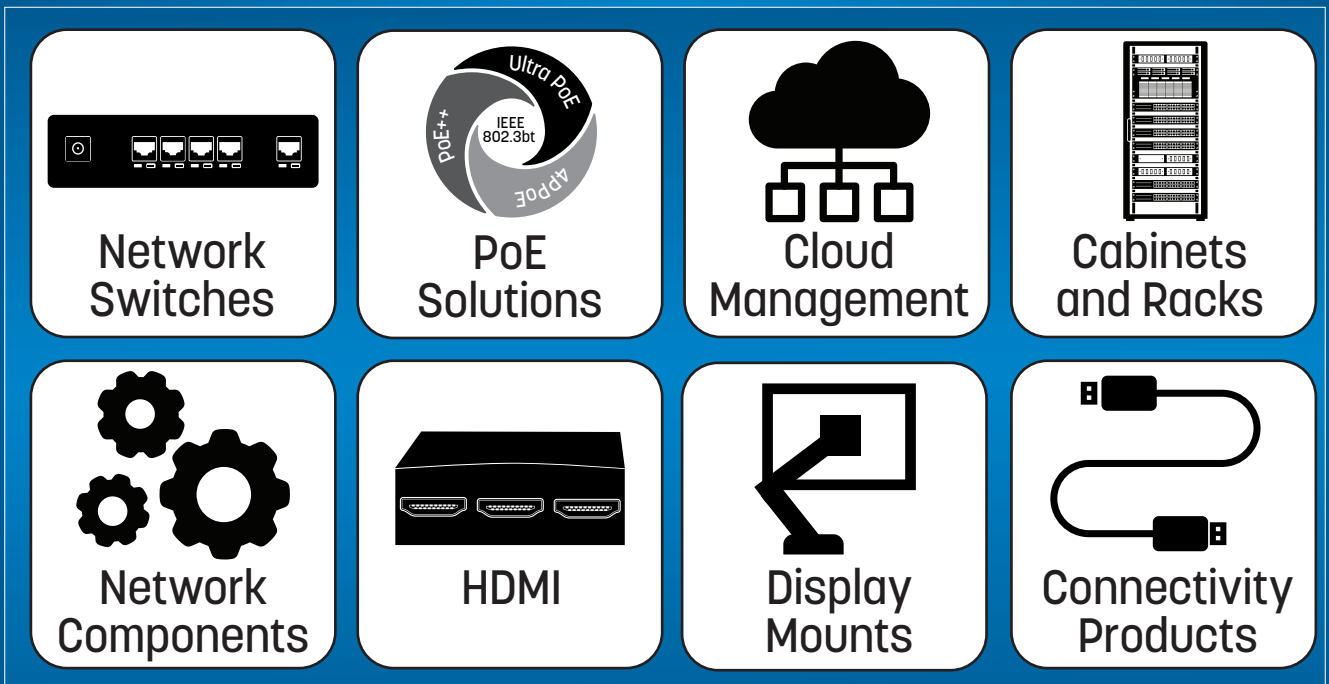

# INTELLINET®

NETWORK SOLUTIONS

## Installer Essentials 2022



Featuring a full line of active infrastructure components



[intellinetnetwork.eu](http://intellinetnetwork.eu)  
The Installer's Choice since 1987



**Company with Over  
35 Years of Market  
Experience**

Founded in 1987, Manhattan and Intellinet Network Solutions were one of the first European-owned cable companies in Taiwan.



**ISO 9001:2015  
Certified**

You can count on service and performance in accordance with ISO 9001:2015.



**Global Expertise,  
Local Mentality**

With offices in North America, Europe and Asia, we're keen on international market needs and can swiftly overcome challenges on a global scale.



**Guaranteed  
Quality**

Our In-house quality-control teams test each product before it's shipped to personally ensure the excellence that's synonymous with the Manhattan and Intellinet Network Solutions brands.



**Superior  
Warranty**

To show our commitment to superior quality, we offer a 3-year-warranty on all active products and a lifetime warranty on almost all passive products.



**On-going Product  
Evolution**

We are capturing unfiltered feedback, ideas and inspiration to improve and enhance product experience.



**One-Stop  
Shop**

Manhattan and Intellinet Network Solutions are your comprehensive source for network and connectivity with more than 2000 products.



**Staff with Over 65  
Years of Industry  
Experience**

Our product and support managers feature a combined industry experience of over 65 years to provide you with expertise and knowledge you can trust.

Founded in 1987, IC Intracom manufactures and distributes high quality networking and consumer electronics components under its two brands Manhattan and Intellinet Network Solutions.

Through OEM relationships and strategic partnerships in the IT channels, products we manufacture are available from more than 70,000 companies around the globe. We do this with enhanced features, simplicity, quality and performance at reasonable prices. We work hard to provide the right tools, so your customers can focus on what's important to them...and so can you.

We stand by our products with industry leading warranties that provide outstanding overall value. Our dedicated quality assurance team is located overseas and is responsible for thorough inspections to ensure products meet customer's expectations, specifications and quality standards. Our aim is to be your primary source for your product sourcing needs.

## TABLE OF CONTENTS

CABINETS	4-20
KVM SWITCHES	14-16
PDU's AND POWER CABLES	21-23
SHELVES & OTHER CABINET ACCESSORIES	24-27
PATCH PANELS	28-29
10" PRODUCTS	30-31
KEYSTONE JACKS, COUPLERS & OTHER ACCESSORIES	32-33
TOOLS AND TESTERS	34
MODULAR PLUGS	35
NETWORK CABLES	36-41
SWITCHES	42-50
WIRELESS ACCESS POINTS AND AP CONTROLLER	51
SFP TRANSCEIVERS	52
DAC CABLES	53
POE INJECTORS, EXTENDERS & SPLITTERS	54-57
MEDIA CONVERTERS	58
NETWORK ADAPTERS	59
HDMI AND OTHER VIDEO EXTENDERS	60-62
SIGNAL SPLITTERS	63
HDMI SWITCHES	64
DOCKS & DOCKING STATIONS	65-66
AUDIO/VIDEO CONVERTERS	67-70
SOHO NETWORK, KVM, HDMI AND SHARING SWITCHES	71
USB HUBS	72-73
HDD/SSD ACCESSORIES	74
HDMI CABLES	76-77
DISPLAYPORT & MINI DISPLAYPORT CABLES	78
DVI, VGA & AUDIO CABLES	79
USB CABLES	80-82
BARCODE SCANNERS	83-85
SERIAL & PARALLEL CONVERTERS	86
DISPLAY MOUNTS	87-120
PROJECTOR MOUNTS	121-122
TABLET AND OTHER MOUNTS	123
CHARGING CABINETS	124-127
CHARGING WALL PLATES	128
INDEX	130-131

**intellinetnetwork.eu | manhattanproducts.eu**

© IC Intracom. All rights reserved. Manhattan and Intellinet Network Solutions are globally registered trademarks of IC Intracom. Other trademarks and trade names are the property of their respective owners. Some product images are simulated, actual appearance may vary. Distribution or reproduction of this document and use or disclosure of the contents herein are prohibited, unless specifically authorized. Some products may be discontinued and are only available while supplies last

Copyright © 2022



# Your Comprehensive Network Solution



## Sample Cabinet Configuration:

42U Standard Server Cabinet

Cable Entry Panel

Shielded Patch Panels

Cable Management Panels

48-Port Gigabit PoE+ Managed Switch

14-Slot Media Converter Chassis

Multimode Media Converters

16-Port Rackmount Console KVM Switch

Shielded RJ45 Modular Plugs, 90 pcs in jar

Cutter Tool from 4-Piece Network Tool Kit

Blank Panel, 4U

Rackmount 6-Way Power Strip

... and much more. Find all your networking needs for small and medium-sized businesses on the following pages.

# Which **CABINET** should you choose? Here are your **POINTS OF REFERENCE**:

## Basic | Good



- Low-cost, entry-level solution
- One lock per side panel
- Ships flatpacked only
- Maximum static load 600 kg



## Standard | Better



- Mid-level, balanced solution
- Maximum static load 1500 kg
- One lock per side panel
- Ships flatpacked or assembled



## Premium | Best



- Superior, high-level solution
- Aluminum frame
- Maximum static load 2000 kg
- Split-side panels for easier access
- 4-Point door lock
- Two locks per side panel
- Ships flatpacked or assembled



## Save **SPACE** and **MONEY** with our convenient **FLATPACKS**

**01**

Fast



**03**

Easy

Assembled in  
**15** minutes.

Most convenient  
flatpack system  
ever developed

Up to **60%** transport and  
warehouse space reduction

Frame will be  
assembled  
with only  
**8** screws.

Can be  
installed by  
one person.

**02**

Convenient



**04**

Efficient







19" Rackmount



Maximum Static Load of 2000 kg



Curved Perforated Front & Rear Door



Zinc-Plated 19" Mounting Rails

**AL**

Aluminum Frame



Antistatic Powder Coating on All Panels



Multipoint Door Lock



Easily Removable and Lockable Split-Side Panels

**IP 20**

IP20-Rated Housing



Cable Entries at Top and Bottom

**3 Year**



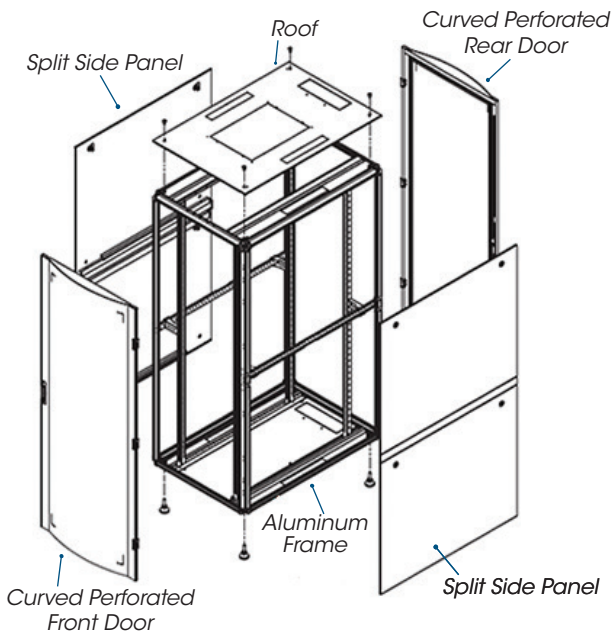





Three-Year Warranty



**NEW**

Flatpack Model #	Assembled Model #	U	Height (mm)	Width (mm)	Depth (mm)	Adjustable Depth Range (mm)	Color
715546	714303	26	1322	600	1000	129-829	Black
715553	715676	26	1322	600	1000	129-829	Gray
715560	715683	36	1589	800	1000	129-829	Black
715577	715690	36	1589	800	1000	129-829	Gray
715584	715706	42	2033	800	1000	129-829	Black
715591	715713	42	2033	800	1000	129-829	Gray





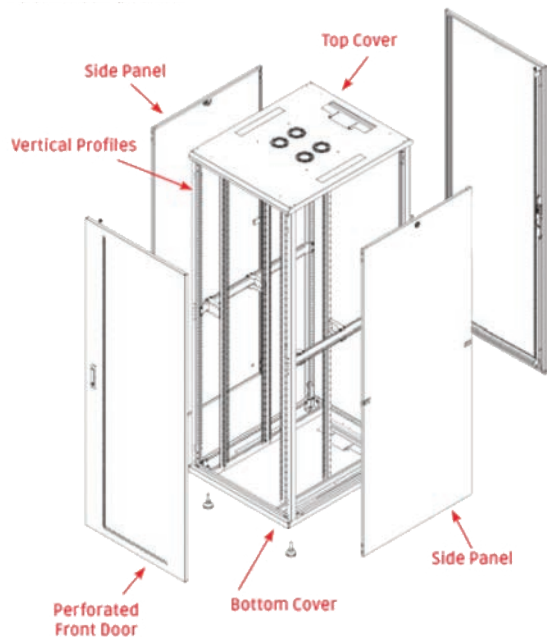



-  19" Rackmount
-  Maximum Static Load of 1500 kg
-  Perforated Front and Rear Door
-  Zinc-Plated 19" Mounting Rails
-  Multipoint Door Lock
-  Antistatic Powder Coating on All Panels
-  Cable Entries at Top and Bottom
-  Easily Removable and Lockable Side Panels
-  IP20-Rated Housing
-  Three-Year Warranty



Flatpack Model #	Assembled Model #	U	Height (mm)	Width (mm)	Depth (mm)	Adjustable Depth Range (mm)	Color
713245	713344	26	1322	600	1000	123-773	Black
713207	713351	26	1322	600	1000	123-773	Gray
713672	-	26	1322	600	1200	123-973	Black
713252	713320	36	1766	600	1000	123-773	Black
713214	713337	36	1766	600	1000	123-773	Gray
713696	715164	36	1766	600	1200	123-973	Black
713269	713306	42	2033	600	1000	123-773	Black
713221	713313	42	2033	600	1000	123-773	Gray
713719	715201	42	2033	600	1200	123-973	Black
713276	713283	42	2033	800	1000	123-773	Black
713238	713290	42	2033	800	1000	123-773	Gray
713733	715317	42	2033	800	1200	123-973	Black
714129	-	47	2280	800	1000	123-773	Black
714105	-	47	2280	800	1200	123-973	Black





-  19" Rackmount
-  Maximum Static Load of 600 kg
-  Perforated Front & Rear Door
-  Zinc-Plated 19" Mounting Rails
-  Multipoint Door Lock
-  Antistatic Powder Coating on All Panels
-  Cable Entries at Top and Bottom
-  Easily Removable and Lockable Side Panels
-  IP20-Rated Housing
-  Three-Year Warranty

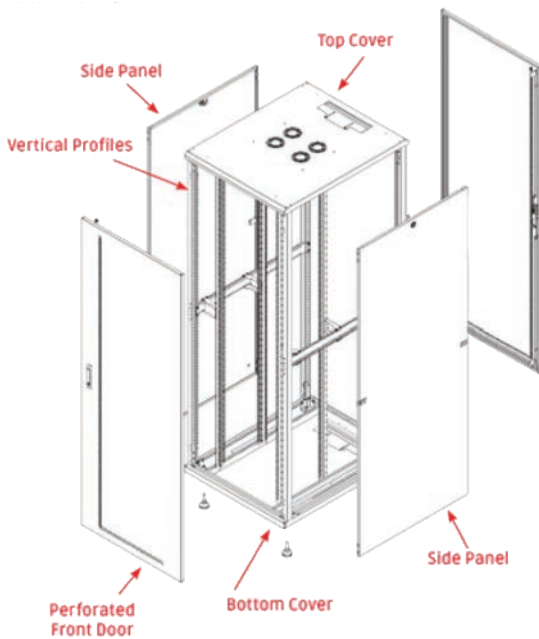

Flatpack Model #	U	Height (mm)	Width (mm)	Depth (mm)	Adjustable Depth Range (mm)	Color
715423	26	1322	600	1000	123-773	Black
715430	26	1322	600	1000	123-773	Gray
715447	36	1589	600	1000	123-773	Black
715454	36	1589	600	1000	123-773	Gray
715461	42	2033	600	1000	123-773	Black
715478	42	2033	600	1000	123-773	Gray





19" Rackmount



Maximum Static Load of 2000 kg



Tempered-Glass Door



Zinc-Plated 19" Mounting Rails

**AL**

Aluminum Frame



Antistatic Powder Coating on All Panels



Single-Point Door Lock



Easily Removable and Lockable Side Panels

**IP 20**

IP20-Rated Housing



Cable Entries at Top and Bottom

**3 Year**

Three-Year Warranty

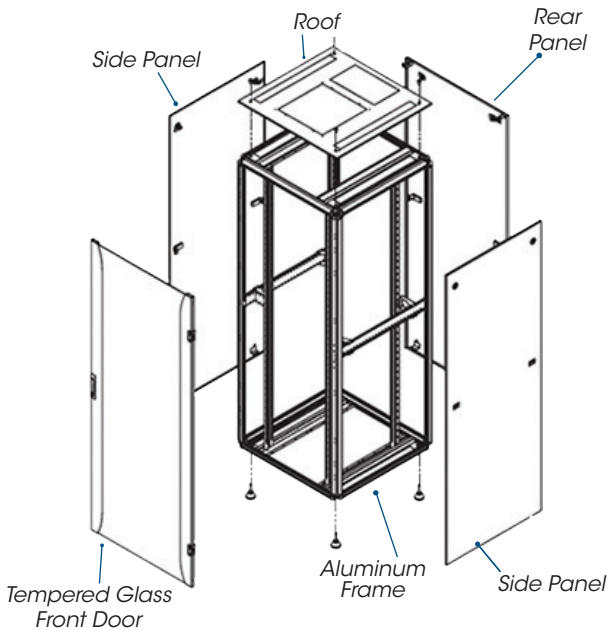

Flatpack Model #	Assembled Model #	U	Height (mm)	Width (mm)	Depth (mm)	Adjustable Depth Range (mm)	Color
715485	714297	22	1322	600	800	129-629	Black
715492	715720	22	1322	600	800	129-629	Gray
715508	715737	32	1589	600	800	129-629	Black
715515	715744	32	1589	600	800	129-629	Gray
715522	715751	42	2033	600	800	129-629	Black
715539	715768	42	2033	600	800	129-629	Gray



19" Rackmount



Maximum Static Load of 1500 kg



Tempered-Glass Door



Zinc-Plated 19" Mounting Rails



Single-Point Door Lock



Antistatic Powder Coating on All Panels



Cable Entries at Top and Bottom



Easily Removable and Lockable Side Panels



IP20-Rated Housing



Three-Year Warranty

Flatpack Model #	Assembled Model #	U	Height (mm)	Width (mm)	Depth (mm)	Adjustable Depth Range (mm)	Color
713061	713627	16	887	600	600	123-373	Black
712927	713634	16	887	600	600	123-373	Gray
713078	713603	22	1144	600	600	123-373	Black
712934	713610	22	1144	600	600	123-373	Gray
713085	713566	22	1144	600	800	123-573	Black
712941	713573	22	1144	600	800	123-573	Gray
715904	715928	22	1144	800	800	123-573	Black
715911	715935	22	1144	800	800	123-573	Gray
713092	713580	26	1322	600	600	123-373	Black
712958	713597	26	1322	600	600	123-373	Gray
713108	713542	26	1322	600	800	123-573	Black
712965	713559	26	1322	600	800	123-573	Gray
713115	713528	32	1588	600	600	123-373	Black
712972	713535	32	1588	600	600	123-373	Gray
713122	713481	32	1588	600	800	123-573	Black
712989	713498	32	1588	600	800	123-573	Gray
713139	713405	32	1588	800	800	123-573	Black
712996	713412	32	1588	800	800	123-573	Gray
713146	713504	36	1766	600	600	123-373	Black
713009	713511	36	1766	600	600	123-373	Gray
713153	713467	36	1766	600	800	123-573	Black
713016	713474	36	1766	600	800	123-573	Gray
713160	713382	36	1766	800	800	123-573	Black
713023	713399	36	1766	800	800	123-573	Gray
713177	713443	42	2033	600	600	123-373	Black
713030	713450	42	2033	600	600	123-373	Gray
713184	713429	42	2033	600	800	123-573	Black
713047	713436	42	2033	600	800	123-573	Gray
713191	713368	42	2033	800	800	123-573	Black
713054	713375	42	2033	800	800	123-573	Gray



19" Rackmount



Maximum Static Load of 600 kg



Tempered-Glass Door



Zinc-Plated 19" Mounting Rails



Single-Point Door Lock



Antistatic Powder Coating on All Panels



Cable Entries at Top and Bottom



Easily Removable and Lockable Side Panels



IP20-Rated Housing



Three-Year Warranty

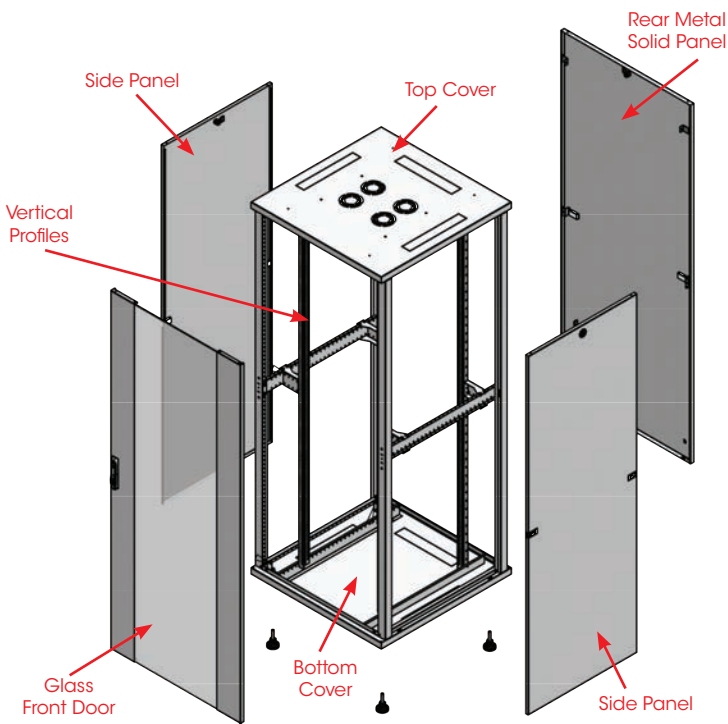

Flatpack Model #	U	Height (mm)	Width (mm)	Depth (mm)	Adjustable Depth Range (mm)	Color
715362	22	1144	600	800	123-573	Black
715379	22	1144	600	800	123-573	Gray
715386	32	1588	600	800	123-573	Black
715393	32	1588	600	800	123-573	Gray
715409	42	2033	600	800	123-573	Black
715416	42	2033	600	800	123-573	Gray



[intellinetnetwork.eu/cabinetfinder](http://intellinetnetwork.eu/cabinetfinder)

Find the right  
Accessories  
for Racks &  
Cabinets  
Online:



[intellinetnetwork.eu/cabinetaccessories](http://intellinetnetwork.eu/cabinetaccessories)



**The most compact data center on the market**



### SPACE-SAVING

- Sturdy cabinet supports up to 2,000 kg
- Fits to and within your office environment
- No installation construction or raised floors required



### ENERGY-EFFICIENT

- Cool the equipment, not an entire room
- Reduce power consumption
- Reduce utility bills



### VERSATILE

- Height options from 24U to 42U
- Casters included to simplify relocation
- Available in black and gray
- IP54-rated housing

Management Considerations	Server Room Construction	Micro Datacenter
Initial Costs	High	Low
Construction Time	Long	Short
Flexibility	Low	High
Cooling Efficiency	Low	High
Low Scalability	Low	High

About **67%** initial COST REDUCTION

Model #	U	Height (mm)*	Width (mm)	Depth (mm)	Cooling Unit	Shipment	Color
714587	24	1749	600	1000	4 kW	Assembled	Black
714594	24	1749	600	1000	4 kW	Assembled	Gray
714549	36	2283	600	1000	4 kW	Assembled	Black
714556	36	2283	600	1000	4 kW	Assembled	Gray
714501	42	2550	600	1000	4 kW	Assembled	Black
714518	42	2550	600	1000	4 kW	Assembled	Gray
714464	42	2582	800	1000	4 kW	Assembled	Black
714471	42	2582	800	1000	4 kW	Assembled	Gray



### Sealed protection against dust and water

These IP55 cabinets are equipped even for challenging environment conditions. Their IP55-rated, powder coated steel housing is compliant with the IEC standard EN 60529 for safe protection against dust ingress and water jets from any direction. Sealed cable glands allow for cable entry. To ensure the neatly sealed design, the cabinet comes fully assembled, which also makes your installation quick and convenient.

#### Industrial IP55 19" Wall Mount Cabinet with Integrated Fans

600 mm Depth, Roof-mount 2-Fan Ventilation Unit, Dust- and Water-proof Enclosure, Assembled



**NEW**

Model #	U	Height (mm)	Width (mm)	Depth (mm)	Weight (kg)	Color
716086	6	370	615	600	32	Gray
716093	9	500	615	600	36	Gray
716109	12	635	615	600	39	Gray
716123	18	902	615	600	46	Gray

#### Industrial IP55 19" Floor-Standing Cabinet with Integrated Fans

800 mm Depth, Floor-mount 4-Fan Ventilation Unit, Dust- and Water-proof Enclosure, Assembled



**NEW**

Model #	U	Height (mm)	Width (mm)	Depth (mm)	Weight (kg)	Color
716130	27	1479	600	800	83	Gray
716147	42	2145	600	800	100	Gray

# Convenient Access and Control

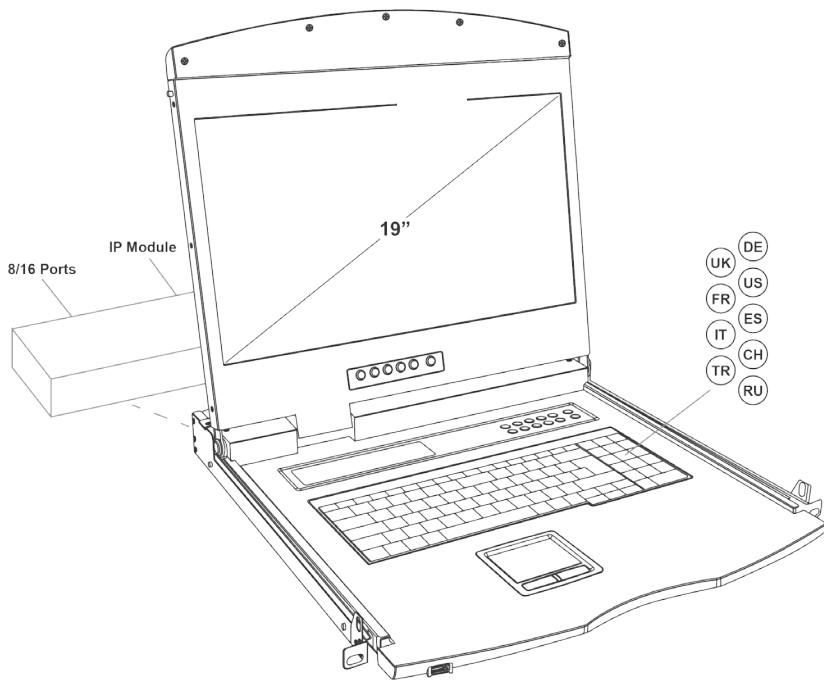

## How the modular system works



### Rackmount Console

- Manage USB or PS/2 computers from one keyboard, monitor and mouse
- Gain complete control with easy-to-use OSD interface
- Standard 19" 1U rack drawer
- For cabinets with depths from 600 mm to 1000 mm
- Compatible with Windows, Mac and Unix

**REQUIRES**  
KVM Module

**Other keyboard layouts available on request**

### Keyboard Layouts:

**19" LCD with VGA & Cat5 Connection** .....

508032 | 507738

Use with modules 507776, 507844, 507882, 507899

**19" LCD with DVI Connection** .....

508117 | 507745

Use with module 507912

**REQUIRES**  
Rackmount  
Console



**Modular 8-Port VGA KVM Switch**

[507776] For Use with Intellinet Product Numbers 507738 and 508032

- Supports USB or PS2 and VGA
- Eight 4-in-1 USB/PS/2 connection cables included

**REQUIRES**  
Rackmount  
Console



**Modular 16-Port VGA KVM Switch**

[507844] For Use with Intellinet Product Numbers 507738 and 508032

- Supports USB or PS2 and VGA
- Sixteen 4-in-1 USB/PS/2 connection cables included

**REQUIRES**  
Rackmount  
Console



**Modular 8-Port CAT5 VGA KVM Switch**

[507882] For Use with Intellinet Product Numbers 507738 and 508032

- Supports USB or PS2 and VGA
- Eight RJ45 Dongles with 3-in-1 (PS2) and 2-in-1 (USB) connections

**REQUIRES**  
Rackmount  
Console



**Modular 16-Port CAT5 VGA KVM Switch**

[507899] For Use with Intellinet Product Numbers 507738 and 508032

- Supports USB or PS2 and VGA
- Sixteen RJ45 Dongles with 3-in-1 (PS2) and 2-in-1 (USB) connections

**REQUIRES**  
Rackmount  
Console



**Modular 8-Port DVI KVM Switch**

[507912] For Use with Intellinet Product Numbers 507745 and 508117

- Supports USB, Audio and DVI
- Eight USB, Audio and DVI-D connection cables included

**NEW**



**2-Port DisplayPort KVM Switch**

[153546] DP 1.2 Single-Display Connections, 4K@60Hz, USB Connections, 3.5 mm Audio and Mic Connections, USB 2.0 Hub, Black

**NEW**



**2-Port Dual-Monitor HDMI KVM Switch**

[153522] HDMI Dual-Display Connections, 4K@30Hz, USB Connections, 3.5 mm Audio and Mic Connections, USB 2.0 Hub, Black

**NEW**



**4-Port Dual-Monitor HDMI KVM Switch**

[153539] HDMI Dual-Display Connections, 4K@30Hz, USB Connections, 3.5 mm Audio and Mic Connections, USB 2.0 Hub, Black



**8-Port HDMI KVM Switch**

[152785] Eight HDMI and Eight USB-B Ports, Full HD, set of eight USB cables included



**8-Port Rackmount KVM Switch**

[506441] Combo USB + PS/2, On-Screen Display, Cables included



**16-Port Rackmount KVM Switch**

[506496] Combo USB + PS/2, On-Screen Display, Cables included

**NEW**



**1080p HDMI KVM over IP Extender Kit**

[207683] Extends a 1080p@60Hz HDMI Signal up to 120 m over a Cat6 Cable or an IP-enabled Network, USB-A Ports for PC/Mouse/Keyboard on Transmitter and Receiver

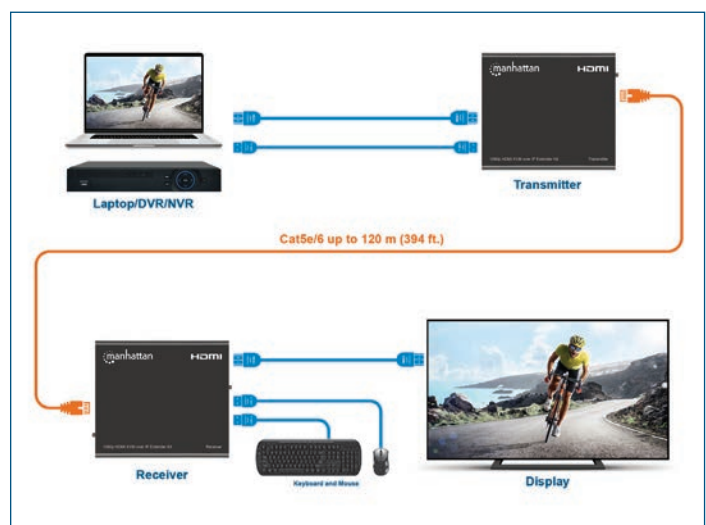





Tempered-Glass Door Opens 180°

Removable & Lockable Sides with 19" Standard Models\*

Reversible Front Door

Galvanized SPCC Steel Frame

Removable Sides with 19" Double-Section Models\*

3 Year Three-Year Warranty

\*Sides of 10" models not removable



Rails with static load up to 30 kg



Earthing kit included



**Double-Section** models make access to the rear cabling easy

Black Model #	Gray Model #	Special Feature	U	Height (mm)	Width (mm)	Depth (mm)
711692	711708	10" Format	6	320	300	300
711739	711760		6	370	600	450
711753	711746		6	370	600	600
711814	711838		9	500	600	450
711845	711852	Double-Section	9	500	600	550
712071	711821		9	500	600	600
711906	711920		12	635	600	450
712088	711913		12	635	600	600
711982	712002		15	770	600	450
712019	712026	Double-Section	15	770	600	550
711975	711999		15	770	600	600
712033	712064		20	994	600	450
712057	712040		20	994	600	600

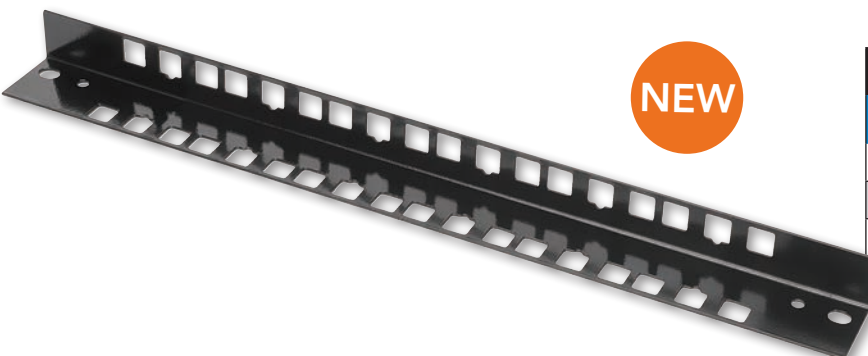

**NEW**

Model #	Description
<b>Spare Rails for 19" Wall Mount Cabinets</b>	
712439	6U, 2-piece set, black
712446	9U, 2-piece set, black
712453	12U, 2-piece set, black
712705	15U, 2-piece set, black



 Tempered-Glass Door Opens 180°

 Galvanized SPCC Steel Frame

 Reversible Front Door

 Removable Sides with Standard Models\*

**3** Year  
Year Warranty

\*Sides of double-section models not removable

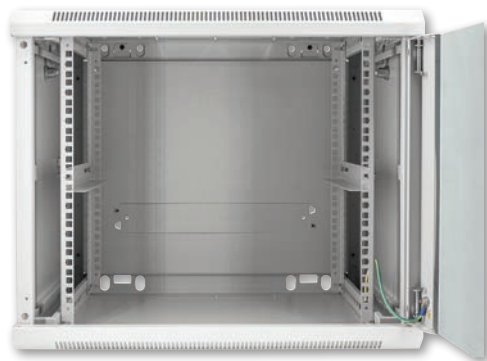

Black Model #	Gray Model #	Special Feature	U	Height (mm)	Width (mm)	Depth (mm)
713740	713757	Double-Section	6	327	540	450
713825	713832	Double-Section	6	327	540	600
711715	711722		6	370	570	450
713764	713771	Double-Section	9	460	540	450
713849	713856	Double-Section	9	460	540	600
711777	711784		9	500	570	450
711791	711807		9	500	570	600
713788	713795	Double-Section	12	593	540	450
713863	713870	Double-Section	12	593	540	600
711869	711876		12	635	570	450
711883	711890		12	635	570	600
713801	713818	Double-Section	15	725	540	450
713887	713894	Double-Section	15	725	540	600
711937	711944		15	770	570	450
711951	711968		15	770	570	600

**Low-Profile 19" Wall Mount Cabinet with 4U Horizontal and 2U Vertical Rails**

Slim, Space-saving Enclosure with Only 170 mm Depth

**Ideal for AV, Multimedia and Surveillance Applications**

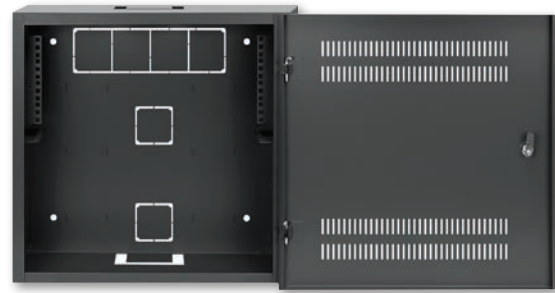

Black Model #	Gray Model #	U	Height (mm)	Width (mm)	Depth (mm)	Weight (kg)
713689	713641	4 (horizontal) 2 (vertical)	170	550	540	8.5

**19" Basic Wall Mount Cabinets**

Your Economy Option with Good Quality at Low Price, Flatpack

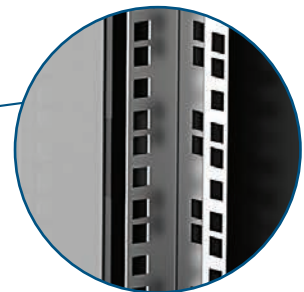



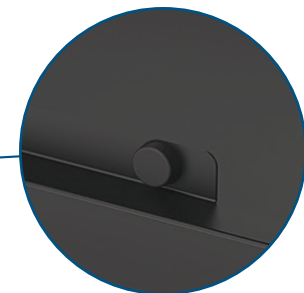

"S-shaped" mounting rails instead of regular "L-shaped" mounting rails for more stability.



Rubber feet to protect the glass door in daily use.

Black Model #	Gray Model #	U	Height (mm)	Width (mm)	Depth (mm)	Weight (kg)
714143	714150	6	353	540	400	10
714785	714792	6	353	540	560	12
714174	714167	9	487	540	400	12
714808	714815	9	487	540	560	15

-  19" Rackmount
-  Option to Use Casters or Feet (included)
-  Fast, Easy Setup with Hassle-Free Assembly
-  Numbered Rackmount Spaces
-  **3** Year Warranty



Model #	Type	# of Posts	U	Height (mm)	Width (mm)	Depth (mm)	Shipment	Color
714648	Desktop	2	8	416	504	294	Flatpack	Black
714747	Desktop	2	12	584	504	294	Flatpack	Black
714228	Floor-standing	2	26	1295	600	603	Flatpack	Black
714235	Floor-standing	2	42	2007	600	603	Flatpack	Black
714242	Floor-standing	4	26	1295	515	559	Flatpack	Black
714259	Floor-standing	4	45	2140	515	559	Flatpack	Black
714419	Floor-standing	4	48	2273	515	559	Flatpack	Black



**5"** Depth

**19"** Use with 19" Patch Panels

 Screws Included

**19" Hinged Wall Bracket**  
 402446 2U  
 402439 1U



# FEATURED PRODUCT



19" Rackmount



Monitors Power, Temperature and Humidity

**16A**

Total Current

**8**

Ports



### 19" Intelligent 8-Port PDU

- Eight-port, IEC320 C13 power output with total current of 16 A
- Current, Voltage (total input) measurement
- Built-in temperature and humidity sensor monitors the operating environment
- Embedded technology, supports Java and web browsing
- Customizable Warning and Overload alarms
- Power-outlet delay-time configurable to prevent the possibility of a power surge to the integral power supply
- Power cycle of each port via web interface
- LED indicates power-supply condition of each power outlet
- Digital display shows real-time value of voltage and current, IP address, or temperature and humidity
- Built-in lightning-protection circuit and voltage-surge circuit

163682



C19 Output;  
Rear C20 Input



Removable 2 m  
Power Cord

**19" 1U Rackmount 8-Output C19 Power Distribution Unit**  
163613



C13 Output;  
Rear C20 Input



Removable 2 m  
Power Cord

**19" 1U Rackmount 8-Output C13 Power Distribution Unit**  
163620



Clamp Holds Power  
Cable in Place



C13 Output;  
Rear C20 Input



Removable 2 m  
Power Cord

**19" 1U Rackmount Anti-Shedding 8-Output C13 Power Distribution Unit**  
163651





- Double Air Switch Power Protection
- 1.6 m Power Cord

**19" 1.5U Rackmount 6-Output Power Distribution Unit (PDU)**  
711432



- On/Off Switch
- Surge Protection
- 3 m Power Cord

**19" 1.5U Rackmount 6-Output Power Distribution Unit (PDU)**  
713962



- On/Off Switch
- 3 m Power Cord

**19" 1.5U Rackmount 8-Way Power Strip - German Type**  
207157



- LED Indicator
- Surge Protection
- 3 m Power Cord

**19" 1.5U Rackmount 7-Output Power Distribution Unit (PDU)**  
714006



- On/Off Switch
- Overload Protection
- 3 m Power Cord

**19" 1U Rackmount 8-Output Power Distribution Unit (PDU)**  
713986



- LED Indicator
- 1.6 m Power Cord

**19" 1U Rackmount 8-Output Power Distribution Unit (PDU)**  
714037



- Double Air Switch Power Protection
- 3 m Power Cord

**19" 2U Rackmount 15-Output Power Distribution Unit (PDU)**  
714051



- On/Off Switch
- Overload Protection
- 1.6 m Power Cord

**Vertical Rackmount 12-Output Power Distribution Unit (PDU)**  
714044



- Single Air Switch Power Protection
- 1.6 m Power Cord

**Vertical Rackmount 12-Output Power Distribution Unit (PDU)**  
711449

### PDU with USB Charging Ports



- 16 USB type A sockets
- Up to 2.1 Amps per Port
- On/Off Switch
- 3 m Power Cord

**Vertical Rackmount 16-Port USB-A Power Distribution Unit**  
164498



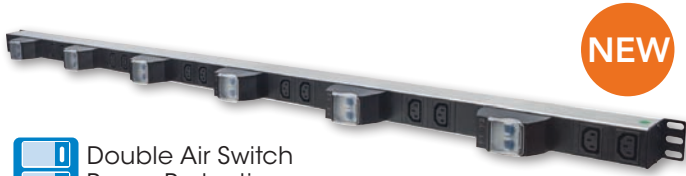

**NEW**

Double Air Switch Power Protection

C13 Output; Rear C14 Input

Removable 2 m Power Cord

**Vertical Rackmount 12-Output C13 Power Distribution Unit 163668**



**NEW**

On/Off Switch

C13 Output; Rear C14 Input

Removable 2 m Power Cord

**Vertical Rackmount 17-Output C13 Power Distribution Unit 163637**



20 x C13 and 4 x C19 Output

Rear C20 Input

Removable 2 m Power Cord

**Vertical Rackmount 24-Output Power Distribution Unit 163675**

Power and SATA Cables	Barcode	Connector 1	Connector 2	Length	Description	Color	Packaging
	300148	C13	CEE 7/4 EU	1.8 m	Power Cable	Black	Bag
	382786	C13	BS 1363 UK	1.8 m	Power Cable	Black	Bag
	301152	C13	C14	1.8 m	Power Cable	Black	Bag
	339100	C7 ("Euro8)	CEE 7/16 EU	1.8 m	Power Cable	Black	Bag
	322843	C7 ("Euro8)	BS 1363 UK	1.8 m	Power Cable	Black	Bag
	371131	C5	CEE 7/4 EU	1.8 m	Power Cable	Black	Bag
	301503	5.25" Male	5.25" Female	20 cm	Power Y Cable	Multi-colored	Bag
	342766	4-Pin	15-Pin	15 cm	SATA Power Cable	Multi-colored	Bag
	340700	7-Pin	7-Pin	50 cm	SATA Data Cable	Red	Bag

Image	Barcode	Accessory	Designed for
	<b>714389</b>	19" Fixed Extending Shelf, adjustable depth 550 - 1000 mm, black	19" cabinets with depths between 600 and 1000 mm and 4-Post Open Frame Racks
	<b>714877</b>	19" Double-Sided Cantilever Shelf, 2U, 450 mm depth, max. load 25 kg, black	Only for 19" 2-Post open frame racks
	<b>712491</b>	19" Cantilever Shelf, 1U, 150 mm depth, max. load 25 kg, black	All 19" cabinets with depths up to 400 mm
	<b>712200</b>	19" Cantilever Shelf, 1U, 150 mm depth, max. load 25 kg, gray	All 19" cabinets with depths up to 400 mm
	<b>715072</b>	19" Cantilever Shelf, 1U, 300 mm depth, max. load 25 kg, black	All 19" cabinets with minimum depths of 400 mm
	<b>715089</b>	19" Cantilever Shelf, 1U, 300 mm depth, max. load 25 kg, gray	All 19" cabinets with minimum depths of 400 mm
	<b>714884</b>	19" Cantilever Shelf, 1U, 300 mm depth, max. load 25 kg, vented, black	All 19" cabinets with minimum depths of 400 mm
	<b>714990</b>	19" Cantilever Shelf, 1U, 300 mm depth, max. load 25 kg, vented, gray	All 19" cabinets with minimum depths of 400 mm
	<b>715102</b>	19" Cantilever Shelf, 1U, 350 mm depth, max. load 25 kg, black	All 19" cabinets with minimum depths of 400 mm
	<b>715119</b>	19" Cantilever Shelf, 1U, 350 mm depth, max. load 25 kg, gray	All 19" cabinets with minimum depths of 400 mm
	<b>714891</b>	19" Cantilever Shelf, 1U, 350 mm depth, max. load 25 kg, vented, black	All 19" cabinets with minimum depths of 400 mm
	<b>715096</b>	19" Cantilever Shelf, 1U, 350 mm depth, max. load 25 kg, vented, gray	All 19" cabinets with minimum depths of 400 mm
	<b>712507</b>	19" Cantilever Shelf, 2U, 250 mm depth, max. load 25 kg, black	All 19" cabinets with minimum depths of 400 mm
	<b>712217</b>	19" Cantilever Shelf, 2U, 250 mm depth, max. load 25 kg, gray	All 19" cabinets with minimum depths of 400 mm
	<b>710954</b>	19" Cantilever Shelf, 2U, 350 mm depth, max. load 15 kg, black	All 19" cabinets with minimum depths of 400 mm
	<b>710947</b>	19" Cantilever Shelf, 2U, 350 mm depth, max. load 15 kg, gray	All 19" cabinets with minimum depths of 400 mm
	<b>712514</b>	19" Cantilever Shelf, 2U, 400 mm depth, max. load 25 kg, vented, black	All 19" cabinets with minimum depths of 600 mm
	<b>712224</b>	19" Cantilever Shelf, 2U, 400 mm depth, max. load 25 kg, vented, gray	All 19" cabinets with minimum depths of 600 mm
	<b>710916</b>	19" Cantilever Shelf, 2U, 400 mm depth, max. load 25 kg, black	All 19" cabinets with minimum depths of 600 mm
	<b>710909</b>	19" Cantilever Shelf, 2U, 400 mm depth, max. load 25 kg, gray	All 19" cabinets with minimum depths of 600 mm

	Barcode	Accessory	Designed for
	<b>NEW</b> 715874	Slide Rails for 19" Cabinets, 2-piece Set, Heavy-duty Support	All 19" cabinets with depths up to 600 mm
	715881	Slide Rails for 19" Cabinets, 2-piece Set, Heavy-duty Support	All 19" cabinets with depths up to 800 mm
	715898	Slide Rails for 19" Cabinets, 2-piece Set, Heavy-duty Support	All 19" cabinets with depths up to 1000 mm
	712613	19" Sliding Shelf, 1U, shelf depth 350 mm, max. load 35 kg, black	All 19" cabinets with depths up to 800 mm
	712323	19" Sliding Shelf, 1U, shelf depth 350 mm, max. load 35 kg, gray	All 19" cabinets with depths up to 800 mm
	712620	19" Sliding Shelf, 1U, shelf depth 550 mm, max. load 35 kg, black	All 19" cabinets with depths up to 1000 mm
	712330	19" Sliding Shelf, 1U, shelf depth 550 mm, max. load 35 kg, gray	All 19" cabinets with depths up to 1000 mm
	714389	19" Fixed Extending Shelf, adjustable depth 550 - 1000 mm, black	19" cabinets with depths between 600 and 1000 mm and 4-Post Open Frame Racks
	714938	19" Storage Drawer, 2U, 350 mm depth, without lock, cover, black	All 19" cabinets with minimum depths of 350 mm between front and rear rails
	714921	19" Storage Drawer, 2U, 350 mm shelf depth, without lock, cover, gray	All 19" cabinets with minimum depths of 350 mm between front and rear rails
	<b>NEW</b> 715829	19" Storage Drawer, 2U, Lockable, 466 mm Depth, Black	All 19" cabinets with minimum depths of 600 mm
	<b>NEW</b> 715843	19" Storage Drawer, 2U, Lockable, 466 mm Depth, Gray	All 19" cabinets with minimum depths of 600 mm
	712859	Ventilation Unit with Thermostat, 2 fans, roof-mount, black	All Intellinet floor-standing cabinets of the Standard and Basic Line
	712781	Ventilation Unit with Thermostat, 2 fans, roof-mount, gray	All Intellinet floor-standing cabinets of the Standard and Basic Line
	712866	Ventilation Unit with Thermostat, 4 fans, roof-mount, black	All Intellinet floor-standing cabinets of the Standard and Basic Line
	712798	Ventilation Unit with Thermostat, 4 fans, roof-mount, gray	All Intellinet floor-standing cabinets of the Standard and Basic Line
	712668	Ventilation Unit, 3 fans, railmount, 1U, black	All floor-standing and 19" Wall Mount cabinets
	712378	Ventilation Unit, 3 fans, railmount, 1U, gray	All floor-standing and 19" Wall Mount cabinets
	<b>NEW</b> 716079	Ventilation Unit, 1 fan, roof-mount, black	All 19" Wall Mount cabinets
	507356	14-Slot Media Converter Chassis, includes redundant power supply, 2U, black	All 19" cabinets with minimum depths of 400 mm



- To organize cabling with cable feeds through the bottom of the cabinet
- To protect from dust and debris
- To stabilize free-standing cabinets
- Ideal for data centers
- Removable covers for cable openings



Black Model #	Gray Model #	Product	Designed for
712880	712811	19" Plinth 90 (H) x 600 (W) x 800 (D) mm	All 19" Floor Standing Racks with 600 (W) x 800 (D) mm
712897	712828	19" Plinth 90 (H) x 600 (W) x 1000 (D) mm	All 19" Floor Standing Racks with 600 (W) x 1000 (D) mm
712903	712835	19" Plinth 90 (H) x 800 (W) x 800 (D) mm	All 19" Floor Standing Racks with 800 (W) x 800 (D) mm
712910	712842	19" Plinth 90 (H) x 800 (W) x 1000 (D) mm	All 19" Floor Standing Racks with 800 (W) x 1000 (D) mm



Screws



Cage Nuts



Washers



Heavy-Duty

With Brakes



Model #	Description
<b>Cage Nut Sets</b>	
712194	20 pcs
711081	50 pcs
713658	100 pcs

Model #	Description
<b>Caster Wheels</b>	
712170	4 pcs, static load 600 kg



4 Grounding/  
Earthing Cables  
with Mounting Kit



Model #	Description
<b>Earthing Kit</b>	
712187	300 mm Length

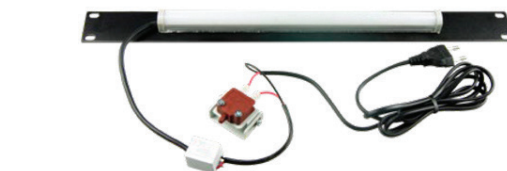

Provides optimum illumination in cabinets



1U Rackmount Space



Provides optimum illumination in cabinets

Model #	Description
<b>LED Light for 19" Cabinets</b>	
715867	Horizontal or Vertical Mount, 11 W, 1.8 m (6 ft.) Power Cord, Aluminum

Model #	Description
<b>LED Light Panel for 19" Cabinets</b>	
715850	Horizontal 19" Rackmount, 1U, 11 W, 1.8 m (6 ft.) Power Cord, Aluminum





Improved Air Flow



Metal



Covers Unused Positions in Cabinet

Model #	Description
<b>Blank Panels</b>	
714822	10", 1U, black
714945	10", 1U, gray
712675	19", 1U, black
712385	19", 1U, gray
714310	19", 1U, toolless, black
714341	19", 2U, toolless, black
712699	19", 4U, black
712408	19", 4U, gray



Horizontal Installation



With Brush Insert

Model #	Description
<b>19" Cable Entry Panels</b>	
712767	1U, with brush, black
712477	1U, with brush, gray
712774	2U, with brush, black
712484	2U, with brush, gray



**4**

Plastic Short Rings



Keeps Cables Neat and Orderly

Model #	Description
<b>19" Cable Management Panels</b>	
711050	1U, black
711043	1U, gray

**NEW**



Horizontal Installation



With Brush Insert

Model #	Description
<b>19" Cable Entry Panel with Cable Tray 2-Pack</b>	
715812	1U, with brush, 2-piece set, black
715836	1U, with brush, 2-piece set, gray



Horizontal Installation



Keeps Cables Neat and Orderly

Model #	Description
<b>19" Cable Management Panels</b>	
714655	1U, Double-sided with covers, black



Horizontal Installation



Keeps Cables Neat and Orderly

Model #	Description
<b>19" Cable Management Panels</b>	
714679	1U, with cover, black

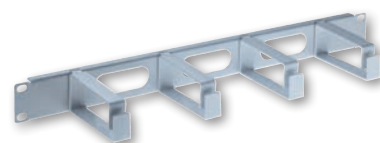

**4**

Plastic Long Rings



Keeps Cables Neat and Orderly

Model #	Description
<b>19" Cable Management Panels</b>	
711074	1U, black
711067	1U, gray



Model #	Category	Ports	Shielding	Color	Height	Format	Note
720427	-	24	-	Black	1U	19" Rackmount	Blank
162470	Cat5e	12	UTP	Black	-	Desktop	Wall-mountable
513548	Cat5e	16	UTP	Black	1U	19" Rackmount	
513470	Cat5e	16	FTP	Black	1U	19" Rackmount	
513555	Cat5e	24	UTP	Black	1U	19" Rackmount	
513678	Cat5e	24	UTP	Black	1U	19" Rackmount	Color-coded ports
513487	Cat5e	24	FTP	Black	1U	19" Rackmount	
503754	Cat5e	24	FTP	Gray	1U	19" Rackmount	
513579	Cat5e	48	UTP	Black	2U	19" Rackmount	
513517	Cat5e	48	FTP	Black	1U	19" Rackmount	
560269	Cat6	12	UTP	Black	-	Desktop	Wall-mountable
720625	Cat6	12	UTP	Black/Silver	1U	19" Rackmount	Lockable
519526	Cat6	16	UTP	Black	1U	19" Rackmount	
720021	Cat6	16	FTP	Black	1U	19" Rackmount	
513692	Cat6	24	UTP	Black	1U	19" Rackmount	Color-coded ports
520959	Cat6	24	UTP	Black	1U	19" Rackmount	
720564	Cat6	24	UTP	Black	1U	19" Rackmount	Lockable
720038	Cat6	24	FTP	Black	1U	19" Rackmount	
720588	Cat6	24	FTP	Black	1U	19" Rackmount	Lockable
720014	Cat6	24	FTP	Gray	1U	19" Rackmount	
560283	Cat6	48	UTP	Black	2U	19" Rackmount	
720908	Cat6a	8	FTP	Black	-	Desktop	
720915	Cat6a	12	FTP	Black	-	Desktop	
720861	Cat6a	24	FTP	Black	1U	19" Rackmount	
720922	Cat6a	24	FTP	Black	0.5U	19" Rackmount	
720854	Cat6a	24	FTP	Gray	1U	19" Rackmount	



### Blank Patch Panel

[720427] 24-Port, 1U, Black



### Wall Mount Patch Panel

[162470] Cat5e, 12-Port, UTP, Black  
[560269] Cat6, 12-Port, UTP, Black



### 19" Color-Coded Patch Panel

[513678] Cat5e, 24-Port, UTP, Black  
[513692] Cat6, 24-Port, UTP, Black



### 19" Patch Panel

[513548] Cat5e, 16-Port, UTP, 1U, Black  
[513555] Cat5e, 24-Port, UTP, 1U, Black  
[519526] Cat6, 16-Port, UTP, 1U, Black  
[520959] Cat6, 24-Port, UTP, 1U, Black



**19" Patch Panel**

- [513579] Cat5e, 48-Port, UTP, 2U, Black
- [560283] Cat6, 48-Port, UTP, 2U, Black



**Locking Cat6 Desktop Patch Panel**

- [720625] 12-Port, UTP, Black/Silver



**Locking 19" Cat6 Patch Panel**

- [720564] 24-Port, UTP, Black
- [720588] 24-Port, FTP, Black



**19" Cat5e Shielded Patch Panel**

- [513470] Cat5e, 16-Port, FTP, 1U, Black
- [513487] Cat5e, 24-Port, FTP, 1U, Black
- [503754] Cat5e, 16-Port, FTP, 1U, Gray
- [513517] Cat5e, 48-Port, FTP, 1U, Black

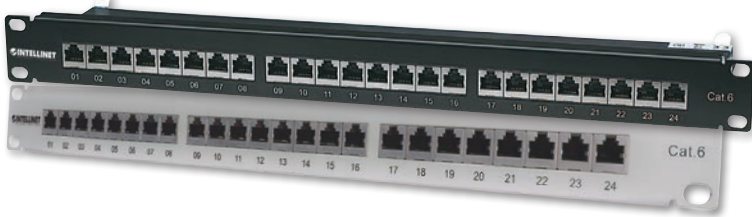

**19" Cat6 Shielded Patch Panel**

- [720021] Cat6, 16-Port, FTP, 1U, Black
- [720038] Cat6, 24-Port, FTP, 1U, Black
- [720014] Cat6, 24-Port, FTP, 1U, Gray



**NEW**

**Cat6a Shielded Desktop Patch Panel**

- [720908] 8-Port, FTP, Black
- [720915] 12-Port, FTP, Black



**NEW**

**19" Cat6a Shielded Patch Panel**

- [720922] 24-Port, FTP, 0.5U (ultra compact), Black



**19" Cat6a Shielded Patch Panel**

- [720861] 24-Port, FTP, 1U, Black
- [720854] 24-Port, FTP, 1U, Gray

## 10" Product Solutions for Small Offices and Home Offices



The network infrastructure in small environments is gaining more and more importance. Whether dealing with small office premises or the home office, a well-organized and structured technical setting is essential to make sure data is transferred from the source to the receiver. With 254 mm (10") solutions from Intellinet Network Solutions, you make sure to have an optimized, space saving network management.





**10" Wall Mount Cabinet**

[711692] 6U, Assembled, Black



**10" Wall Mount Cabinet**

[711708] 6U, Assembled, Gray



**10" 1U Rackmount 4-Output Power Distribution Unit (PDU)**

[714020] EU CEE 7/3 Outlets, With Power Indicator, No Surge Protection, Built-in 1.8 m (5.9 ft.) Power Cord with EU CEE 7/4 Plug



**10" Cat6 Patch Panel**

[720748] 1U, 12 Port, Unshielded, Black



**10" Blank Patch Panel**

[714860] 1U, Ten Ports, Black



**10" Blank Patch Panel**

[714969] 1U, Ten Ports, Gray

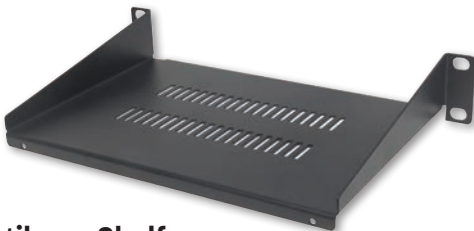

**10" Cantilever Shelf**

[714839] 1U, 150 mm Depth, Vented, Black



**10" Cantilever Shelf**

[714983] 1U, 150 mm (6.1 in.) Shelf Depth, Vented, Gray



**10" Cable Management Panel**

[714846] 1U, Three Large Retaining Rings, Black



**10" Cable Management Panel**

[714952] 1U, Three Large Retaining Rings, Gray

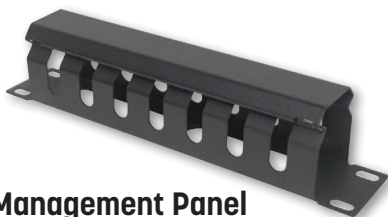

**10" Cable Management Panel**

[714853] 1U, Covered, Black

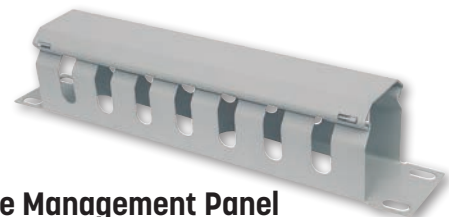

**10" Cable Management Panel**

[714976] 1U, Covered, Gray



**Cat5e Keystone Jack**

- [210355] White
- [210416] Black
- [210546] Blue
- [210997] Green
- [210478] Red
- [210577] Orange
- [210133] Yellow

**Cat6 Keystone Jack**

- [210591] White
- [210720] Black
- [210737] Blue
- [210638] Green
- [210614] Red
- [210775] Orange
- [210584] Yellow

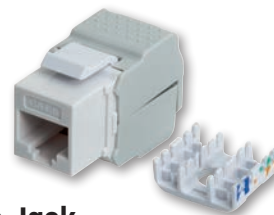

**Cat6 Keystone Jack**

[167062] UTP, White, Tool-less



**Keystone Coupler**

[512008] FTP, for 19" panels, Cat5e



**USB Charging Keystone Jack**

[772167] One Type-A Charging Port, Output 5 V / 1 A



**RJ45 Repair Clips**

- [771443] Transparent blue; 50-pack
- [771436] Transparent; 50-pack
- [771450] Transparent mixed colors; 50pack



**Cat5e Inline Coupler, Keystone Type**

[504775] 8P8C Female to 8P8C Female, UTP, Black



**Locking Keystone Jack**

- [790758] Cat6, UTP, White
- [790772] Cat6a, UTP, White



**Locking Keystone Jack**

- [790765] Cat6, FTP, Metallic
- [790789] Cat6a, FTP, Metallic



**Locking Cat6 Inline Coupler**

- [790802] FTP, Metallic
- [790727] UTP, White



**Locking Cat6 UTP Mount Box**

[771467] 2 Port, UTP, Mount Box, Locking Function, White





**2-Port 10G Shielded RJ45 Wall Plate**

[771900] Cat6

[771917] Cat6a

Flush Mount with Faceplate, STP, Signal White RAL9003

**NEW**



**Surface Mount Patten Box for Wall Plates**

[771894] Extends flush mount wall plates to surface mount, 80 x 80 x 45 mm, Signal White RAL9003

**NEW**



**Toolless RJ45 Plug**

[790482] Toolless RJ45 Modular plug



**2-Port Modular Distributor**

[504195] FTP, used in pairs (one modular distributor on each end of the network cable)



**Cat5e Modular Inline Coupler**

[504768] 8P8C Female to 8P8C Female, FTP, Silver



**Cat6 Junction Box**

[512381] FTP, Silver



**Cat6a 10G Shielded Toolless RJ45 Modular Field Termination Plug**

[790796] For Easy and Quick High-quality Cable Assembly in the Field, STP, for Solid & Stranded Wire, Gold-plated Contacts, Metal Housing

**NEW**

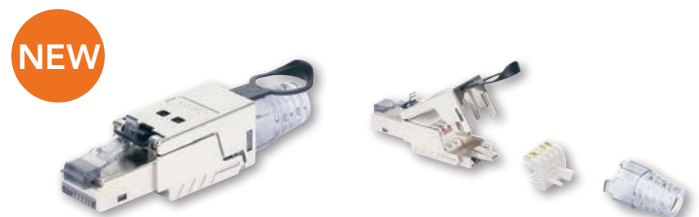

**Cat6a 10G Shielded Toolless RJ45 Modular Field Termination Plug with Pull-ring Release**

[790741] For Easy and Quick High-quality Cable Assembly in the Field, STP, for Solid & Stranded Wire, Gold-plated Contacts, Metal Housing

**NEW**



**Cat8.1 40G Shielded Toolless RJ45 Modular Field Termination Plug**

[791199] For Easy and Quick High-quality Cable Assembly, Ideal for Data Centers, STP, for Solid & Stranded Wire, Gold-plated Contacts, Metal Housing

**NEW**



**Cat8.1 40G Shielded Toolless Keystone Jack**

[771887] For Easy and Quick Snap-in Deployment, Ideal for Data Centers, STP, for Solid & Stranded Wire, Gold-plated Contacts, Metal Housing

**NEW**



### Multifunction Cable Tester

[351898] Tests RJ45 and RJ11



### 4-in-1 Cable Tester

[351911] Tests RJ11, RJ45, USB and BNC



### 5-in-1 Cable Tester

[780094] Tests Ethernet (RJ45), 10Base2 / BNC, RJ11, USB and FireWire



### Net Toner and Probe Kit

[515566] Tone Generator, Tests Datacom, Telecom, Security, Video, and Audio Networks



### Universal Modular Plug Crimping Tool

[211048] For RJ45, RJ12 and RJ11 Modular Plugs



### Universal Modular Plug Crimping Tool and Cable Tester

[780124] 2-in-1 Crimper and Cable Tester – Cuts, Strips, Terminates and Tests



### 4-Piece Network Tool Kit

[780070] 4 Tool Network Kit Composed of LAN Tester, LSA punch down tool, Crimping Tool and Cutter/Stripper Tool



### PoE+ Tester

[780131] Power over Ethernet Plus Test Tool; Detects Endspan, Midspan, IEEE802.3af- and IEEE802.3at



### LSA+ Impact Tool

[504485] For the installation of network cabling and wall plates with LSA+ connections



### CPU Thermal Grease

[701662] Helps Dissipate Damaging Heat to Prolong CPU Life, 1.5 g (0.05 oz.)



Model #	Category	Cable Type	Shielding	Content	Packaging	Gold Plating
<b>Modular Plugs</b>						
<b>790055</b>	Cat5e	2-prong terminal for stranded wire	UTP	100 pcs	Jar	15μ
<b>502399</b>	Cat5e	3-prong terminal for solid wire	UTP	100 pcs	Jar	15μ
<b>790581</b>	Cat5e	2-prong terminal for stranded wire	STP	100 pcs	Jar	15μ
<b>790529</b>	Cat5e	3-prong terminal for solid & stranded wire	STP	100 pcs	Jar	50μ
<b>790574</b>	Cat5e	3-prong terminal for solid wire	STP	100 pcs	Jar	15μ
<b>502344</b>	Cat6	2-prong terminal for stranded wire	UTP	100 pcs	Jar	15μ
<b>790604</b>	Cat6	3-prong terminal for solid wire	UTP	90 pcs	Jar	15μ
<b>790635</b>	Cat6	2-prong terminal for stranded wire	STP	90 pcs	Jar	15μ
<b>790543</b>	Cat6	3-prong terminal for solid & stranded wire	STP	90 pcs	Jar	50μ
<b>790628</b>	Cat6	3-prong terminal for solid wire	STP	90 pcs	Jar	15μ
<b>790666</b>	Cat6A	2-prong terminal for stranded wire	UTP	80 pcs	Jar	15μ
<b>790659</b>	Cat6A	3-prong terminal for solid wire	UTP	80 pcs	Jar	15μ
<b>790550</b>	Cat6A	3-prong terminal for solid wire	UTP	80 pcs	Jar	50μ
<b>790697</b>	Cat6A	2-prong terminal for stranded wire	STP	90 pcs	Jar	15μ
<b>790505</b>	Cat6A	3-prong terminal for solid & stranded wire	STP	70 pcs	Jar	50μ
<b>790680</b>	Cat6A	3-prong terminal for solid wire	STP	90 pcs	Jar	15μ

# Patch Cable GUIDE

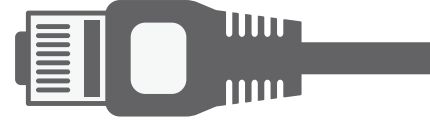
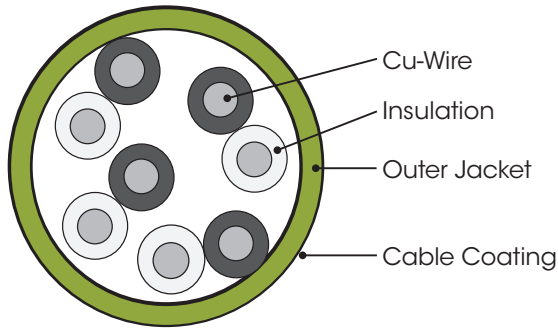
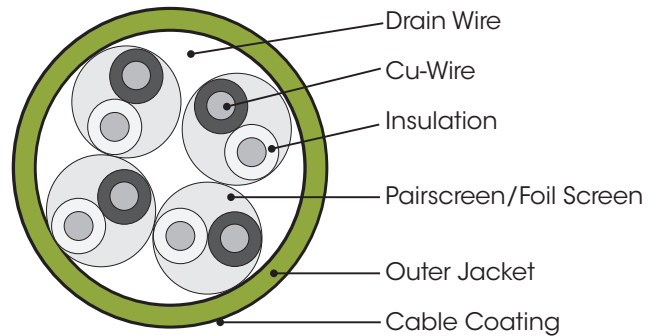
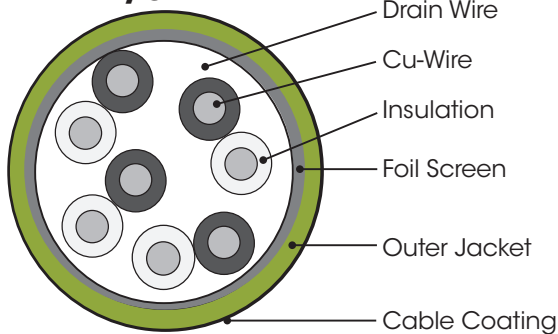
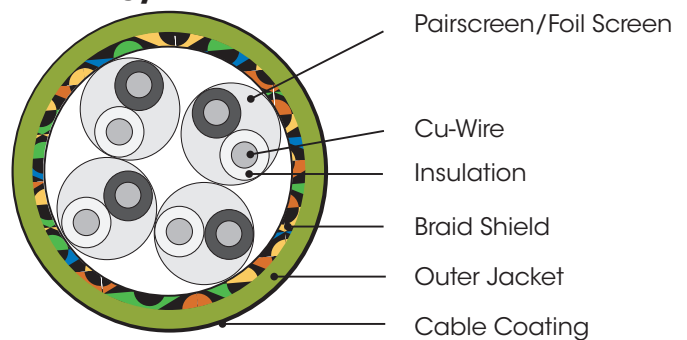
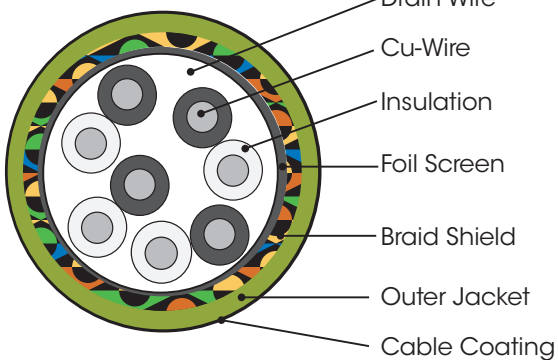
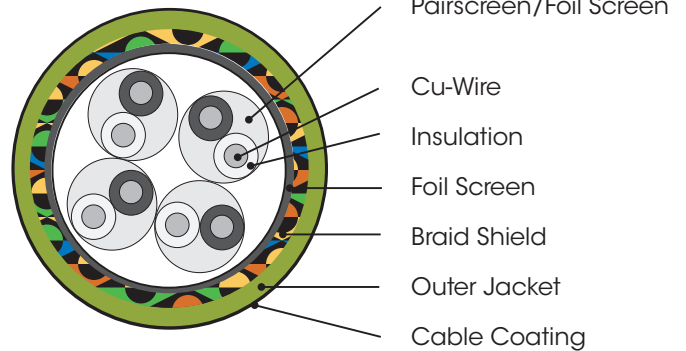
**U/UTP****U/FTP****F/UTP****S/FTP****SF/UTP****SF/FTP**

Industry Acronyms	ISO IEC 11801 Name	Cable Shielding	Pair Shielding
UTP	U/UTP	None	None
STP, ScTP, PiMF	U/FTP	None	Foil
FTP, STP, ScTP	F/UTP	Foil	None
STP, ScTP	S/UTP	Braiding	None
SFTP, S-FTP, STP	SF/UTP	Braiding, Foil	None
SFSFTP, SF-SFTP, SF <sup>2</sup> TP	SF/SFTP	Braiding, Foil	Braiding, Foil
FFTP	F/FTP	Foil	Foil
SSTP, SFTP, STP PiMF	S/FTP	Braiding	Foil
SSTP, SFTP	SF/FTP	Braiding, Foil	Foil



# Cat6a Modular Plugs with Cat7 Raw Cable

The Best Performance for Your Network Infrastructure



## Why Cat6a Modular Plugs?

As there is no official, agreed-upon standard for the Cat7 plug, Intellinet Network Solutions uses the highest official TIA/EIA-approved components to give you the best specification available.

- Cat 7 tested up to 600 MHz
- LSZH—Low Smoke, Zero Halogen
- Suitable for 10 Gigabit networks
- Gold-plated contacts
- 100 % copper
- Lifetime Warranty



Length	Gray	Black	Red	Yellow	Green	Blue	White
0.25 m	740555	740562	740579	740586	740593	740609	741903
0.5 m	740616	740623	740630	740647	740654	740661	741354
1 m	740678	740685	740692	740708	740715	740722	741361
1.5 m	740739	740753	740760	740777	740784	740791	741378
2 m	740807	740814	740821	740838	740845	740852	741385
3 m	740869	740876	740883	740890	740906	740913	741392
5 m	740920	740937	740944	740951	740968	740975	741408
7.5 m	740982	740999	741002	741019	741026	741033	741910
10 m	741040	741057	741064	740746	741071	741088	741415
15 m	741095	741101	741118	741125	741132	741149	741927
20 m	741156	741163	741170	741187	741194	741200	741422
30 m	741217	741224	741231	741248	741255	741262	741439

## GREAT SHIELDING FOR MAXIMUM SIGNAL QUALITY

All of the above cables feature the shielding "S/FTP":

- S = braid shielded;
- FTP = foiled twisted pair: an aluminum foil screen around each pair (aluminum-mylar, referred to as PIMF)

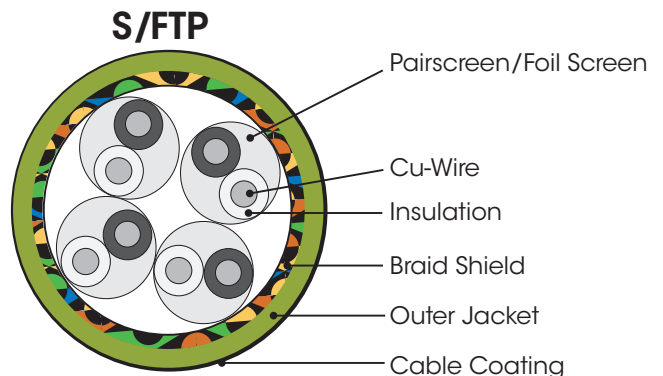

**CCA**



Length	Gray	Black	Red	Yellow	Green	Blue
<b>Cat5e compatible, U/UTP</b>						
0.25 m	737302	347440	737326	737333	737340	737357
0.5 m	318228	318143	318198	325165	318167	318129
1.0 m	318921	320740	318952	318969	318945	318938
1.5 m	336628	338387	338394	338424	338417	338400
2.0 m	318976	320757	319300	319744	318990	318983
3.0 m	319768	320764	319799	319805	319782	319775
5.0 m	319812	320771	319843	319850	319836	319829
7.5 m	319867	320788	319898	319966	319881	319874
10.0 m	325950	345378	325967	325974	325943	325936
15.0 m	319973	320795	320603	320610	319997	319980
20.0 m	345033	345040	325998	325981	326001	326018
<b>Cat5e compatible, F/UTP</b>						
0.25 m	737319					
0.5 m	329880					
1.0 m	329897					
1.5 m	737364					
2.0 m	329903					
3.0 m	329910					
5.0 m	329927					
7.5 m	329934					
10.0 m	329941					
15.0 m	329958					
20.0 m	329965					
<b>Cat5e compatible, SF/UTP</b>						
0.25 m	738934	738941	738958	738965	738972	738989
0.5 m	329989	320368	329996	330466	330442	330459
1.0 m	330473	320375	330480	330510	330497	330503
1.5 m	738996	739009	739016	739023	739030	739047
2.0 m	330527	335645	330534	330565	330541	330558
3.0 m	330572	320399	330589	330619	330596	330602
5.0 m	330626	320405	330633	330664	330640	330657
7.5 m	330671	336673	330688	330718	330695	330701
10.0 m	330831	320429	330848	330725	330855	330862
15.0 m	330732	337212	330749	330770	330756	330763
20.0 m	330787	320443	330794	330824	330800	330817
<b>Cat6 compatible, U/UTP</b>						
0.25 m	739900	739917	739924	730808	730815	739931
0.5 m	340427	342032	342131	342339	342469	342568
1.0 m	340373	342049	342148	342346	342476	342575
1.5 m	340380	342056	342155	342353	342483	342582
2.0 m	334112	342063	342162	342360	342490	342599
3.0 m	334129	342070	342179	342377	342506	342605
5.0 m	336765	343350	343367	343725	343718	343305
7.5 m	336758	342094	342193	342391	342520	342629
10.0 m	336734	343794	343756	343787	343763	343770
15.0 m	336772	342100	342209	342407	342537	342438
20.0 m	336741	730419	735186	730440	730457	730464

100%  
Copper



Length	Gray	Black	Red	Yellow	Green	Blue	White
<b>Cat6 certified, 100% copper, U/UTP</b>							
0.25 m	738095	738835	738859	738873	738897	738910	
0.5 m	738101	738842	738866	738880	738903	738927	
1.0 m	738118	738330	738439	738538	738637	738736	
1.5 m	738125	738347	738446	738545	738644	738743	
2.0 m	738132	738354	738453	738552	738651	738750	
3.0 m	738149	738361	738460	738569	738668	738767	
5.0 m	738156	738378	738477	738576	738675	738774	
7.5 m	738163	738385	738484	738583	738682	738781	
10.0 m	738170	738392	738491	738590	738699	738798	
15.0 m	738187	738408	738507	738606	738705	738804	
20.0 m	738194	738415	738514	738613	738712	738811	
30.0 m	738200	738422	738521	738620	738729	738828	
50.0 m	737272						
<b>Cat6 certified, 100% copper, S/FTP, LSZH</b>							
0.25 m	739788	739795	739801	739818	739825	739832	
0.5 m	733212	735209	735247	735261	735223	735216	735254
1.0 m	733229	735308	736145	735339	735322	735315	735360
1.5 m	739849	739856	739863	739870	739887	739894	
2.0 m	733243	735391	735445	735469	735407	735384	735452
3.0 m	736138	735476	735506	735520	735483	733533	735513
5.0 m	733267	735568	735629	735643	735582	735575	735636
7.5 m	733274	735667	735728	735742	735681	735674	735735
10.0 m	733281	735766	735803	735827	735780	735773	735810
15.0 m	733298	735858	735889	735902	735872	735865	735896
20.0 m	733304	735940	735988	736008	735964	735957	735995
30.0 m	733328	736022	736060	736084	736046	736039	736077
50.0 m	737289						
<b>Cat6a certified, 100% copper, S/FTP, LSZH</b> <span style="border: 1px solid black; padding: 2px;">GHMT Certified</span>							
0.25 m	736992	737012	737029	737036	737043	737050	
0.5 m	317092	318754	319034	350464	350594	350723	
1.0 m	317108	318761	319065	350471	350600	350730	
1.5 m	317139	318778	319089	350488	350617	350747	
2.0 m	317146	318785	319096	350495	350624	350754	
3.0 m	317191	318792	319119	350501	736824	350761	
5.0 m	317245	318808	319126	350518	350648	350778	
7.5 m	317177	318815	319133	350525	350655	350785	
10.0 m	736749	736855	736879	736725	736886	736862	
15.0 m	317320	318822	319225	350532	350662	350792	
20.0 m	737067	737081	737098	737104	737111	737128	
30.0 m	317399	318846	319249	350556	350686	350815	
50.0 m	737296						

# Ideal for building-structure cabling in secondary and tertiary areas

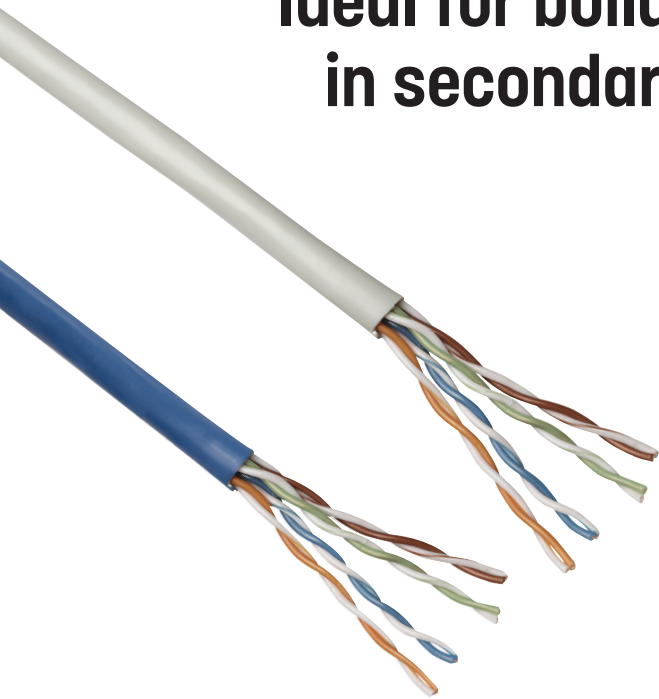

Type	Wire	Color	Length	AWG	Model #
<b>Cat5e Compatible, CCA</b>					
U/UTP	Solid	Gray	305 m	24	<b>362320</b>
<b>Cat5e Certified, Copper</b>					
F/UTP	Solid	Gray	305 m	24	<b>518130</b>
U/UTP	Solid	Gray	305 m	24	<b>325899</b>
F/UTP	Stranded	Gray	305 m	26	<b>337892</b>
<b>Cat6 Compatible, CCA</b>					
U/UTP	Solid	Gray	305 m	23	<b>704663</b>
<b>Cat6 Certified, Copper</b>					
S/FTP	Solid	Gray	305 m	23	<b>341165</b>
U/UTP	Solid	Gray	305 m	23	<b>334136</b>
<b>Cat6a Certified, LSZH, Copper, CPR-Dca Rated</b>					
S/FTP	Solid	Gray	100 m	23	<b>704953</b>
S/FTP	Solid	Gray	305 m	23	<b>705035</b>
<b>Cat7 Certified, LSZH, Copper, CPR-Dca Rated</b>					
S/FTP	Solid	Gray	100 m	23	<b>704922</b>
S/FTP	Solid	Gray	305 m	23	<b>705011</b>
<b>Cat7a Certified, LSZH, Copper, CPR-Dca Rated</b>					
S/FTP	Solid	Gray	100 m	22	<b>704939</b>
S/FTP	Solid	Gray	305 m	22	<b>705028</b>





### ENHANCED SECURITY.

It is impossible to remotely detect a signal being transmitted within a fiber cable. The only way to do so is by actually accessing the optical fiber itself. This makes fiber extremely attractive to governmental bodies, banks and other businesses with major security concerns.

### NO METALLIC COMPONENTS.

Fiber optic cable can be installed in areas with electromagnetic interference (EMI). This includes areas around utility lines, power-carrying lines and railroad tracks. Fiber is also ideal for areas of high lightning-strike incidence.

Length	OM1 Multimode
<b>Duplex Jumper LC/LC 62.5/125µm</b>	
1.0 m	471206
2.0 m	471213
3.0 m	471220
5.0 m	471237
10.0 m	471244
20.0 m	473095
<b>Duplex Jumper LC/SC 62.5/125µm</b>	
1.0 m	471251
2.0 m	471268
3.0 m	471275
5.0 m	471282
10.0 m	471299
20.0 m	473033
<b>Duplex Jumper LC/ST 62.5/125µm</b>	
1.0 m	471305
2.0 m	471312
3.0 m	471329
5.0 m	471336
10.0 m	471343
20.0 m	472975
<b>Duplex Jumper SC/SC 62.5/125µm</b>	
1.0 m	515818
2.0 m	515825
3.0 m	511308
5.0 m	510332
10.0 m	515832
20.0 m	472944
<b>Duplex Jumper ST/SC 62.5/125µm</b>	
1.0 m	515788
2.0 m	515795
3.0 m	510349
5.0 m	510356
10.0 m	515801
20.0 m	751063
<b>Duplex Jumper ST/ST 62.5/125µm</b>	
1.0 m	515757
2.0 m	515764
3.0 m	511216
5.0 m	510325
10.0 m	515771
20.0 m	474214

Length	OM2 Multimode	OM3 Multimode	OM4 Multimode
<b>Duplex Jumper LC/LC 50/125µm</b>			
1.0 m	470308	750868	750875
2.0 m	470315	750134	750882
3.0 m	470322	750066	751162
5.0 m	470339	750080	750899
10.0 m	470346	750097	751032
20.0 m	472753	750905	750981
<b>Duplex Jumper LC/SC 50/125µm</b>			
1.0 m	470353	750912	751049
2.0 m	470377	750158	750929
3.0 m	470384	750165	750936
5.0 m	470391	751094	751056
10.0 m	470407	750523	751179
20.0 m	472814	750943	751186
<b>Duplex Jumper LC/ST 50/125µm</b>			
1.0 m	470360	751117	
2.0 m	470414	751001	
3.0 m	470421	751124	
5.0 m	470438	751131	
10.0 m	470445	751148	
20.0 m	472692	751155	
<b>Duplex Jumper SC/SC 50/125µm</b>			
1.0 m	470001	751025	
2.0 m	470018	750837	
3.0 m	470025	751100	
5.0 m	470032	750844	
10.0 m	470049	750851	
20.0 m	472630	751070	
<b>Duplex Jumper ST/SC 50/125µm</b>			
1.0 m	470100		
2.0 m	470117		
3.0 m	470124		
5.0 m	470131		
10.0 m	470148		
20.0 m	472586		
<b>Duplex Jumper ST/ST 50/125µm</b>			
1.0 m	470056		
2.0 m	470063		
3.0 m	470070		
5.0 m	470087		
10.0 m	470094		
20.0 m	472524		



Length	OS2 Singlemode
<b>Duplex Jumper LC/LC 9/125µm</b>	
1.0 m	516785
2.0 m	750004
3.0 m	471893
5.0 m	516792
10.0 m	516815
20.0 m	750967
<b>Duplex Jumper SC/SC 9/125µm</b>	
1.0 m	470605
2.0 m	470612
3.0 m	470629
5.0 m	470636
10.0 m	470643
20.0 m	750950
<b>Duplex Jumper LC/SC 9/125µm</b>	
1.0 m	473965
2.0 m	473972
3.0 m	472050
5.0 m	473729
10.0 m	473996
20.0 m	750974
<b>Duplex Jumper LC/ST 9/125µm</b>	
1.0 m	474016
2.0 m	750011
3.0 m	516952
5.0 m	516976
10.0 m	474047
20.0 m	516990

## Industrial Switches, 4 - 8 Ports

Model #	PoE	Speed	RJ45 Ports	Special Feature	Managed/ Self-healing	Housing	Integrated Fans	PoE Ports	Power Budget	Page
508247	-	Gigabit	4	Industrial, 2 SFP Ports	-	Desktop & DIN	-	-	-	49
508254	Yes	Gigabit	4	Industrial, 2 SFP Ports	-	Desktop & DIN	-	4	120 W	49
561624	Yes	Gigabit	8	Industrial, PoE Passthrough	-	Desktop & DIN	-	7	120 W	49/50
508261	Yes	Gigabit	8	Industrial, 2 SFP Ports	-	Desktop & DIN	-	8	240 W	49
508278	Yes	Gigabit	8	Industrial, 2 SFP Ports	Yes	Desktop & DIN	-	8	240 W	49

## Non-PoE Switches, 5 - 48 Ports

Model #	PoE	Speed	RJ45 Ports	Special Feature	Managed/ Self-healing	Housing	Integrated Fans	PoE Ports	Power Budget	Page
530378	-	Gigabit	5	-	-	Desktop	-	-	-	45
530347	-	Gigabit	8	-	-	Desktop	-	-	-	45
561068	-	Gigabit	16	-	-	Desktop & Rackmount	-	-	-	45
561815	-	Gigabit	16	-	-	Desktop & Rackmount	-	-	-	45
561273	-	Gigabit	24	-	-	Rackmount	-	-	-	45
561044	-	Gigabit	24	2 SFP Ports	-	Rackmount	-	-	-	45

## Fast Ethernet PoE Switches, 6 - 16 Ports

Model #	PoE	Speed	RJ45 Ports	Special Feature	Managed/ Self-healing	Housing	Integrated Fans	PoE Ports	Power Budget	Page
561686	Yes	Fast Ethernet	6	PoE Extend Mode, 1 High-Power PoE Port	-	Desktop	-	4	65 W	45
561075	Yes	Fast Ethernet	8	1 SFP Combo Port	-	Desktop & Rackmount	-	4	70 W	45
560764	Yes	Fast Ethernet	8	-	-	Desktop	-	8	140 W	46

## Gigabit PoE Switches, 5 - 8 Ports

Model #	PoE	Speed	RJ45 Ports	Special Feature	Managed/ Self-healing	Housing	Integrated Fans	PoE Ports	Power Budget	Page
561228	Yes	Gigabit	5	-	-	Desktop	-	4	60 W	46
561082	Yes	Gigabit	5	PoE Passthrough	-	Desktop	-	4	68 W (via AC) 26 W (via PoE)	50
561174	Yes	Gigabit	5	1 SFP Combo Port	-	Desktop	-	4	80 W	46
561204	Yes	Gigabit	8	-	-	Desktop	-	8	60 W	46

## PoE Switches, 8 - 48 Ports

Model #	PoE	Speed	RJ45 Ports	Special Feature	Managed/ Self-healing	Housing	Integrated Fans	PoE Ports	Power Budget	Page
561679	Yes	Gigabit	8	PoE Passthrough	-	Desktop	-	7	85 W	50
561624	Yes	Gigabit	8	Industrial , PoE Passthrough	-	Desktop & DIN	-	7	120 W	49/50
560641	Yes	Gigabit	8	-	-	Desktop & Rackmount	-	8	140 W	46
561402	Yes	Gigabit	8	2 RJ45 Gigabit Uplink Ports	-	Desktop	1	8	120 W	46
561167	Yes	Gigabit	8	-	Yes	Desktop & Rackmount	1	8	140 W	47
560993	Yes	Gigabit	16	-	-	Rackmount	2	16	220 W	47
561341	Yes	Gigabit	16	2 SFP Ports	Yes	Rackmount	2	16	220 W	47
561198	Yes	Gigabit	16	2 SFP Ports	Yes	Rackmount	2	16	374 W	47
561259	Yes	Gigabit	16	LCD, 2 SFP Ports	-	Rackmount	2	16	370 W	47
561419	Yes	Gigabit	16	4 RJ45 Gigabit & 2 SFP Uplink Ports	-	Rackmount	1	16	300 W	47
561242	Yes	Gigabit	24	2 SFP Ports	-	Rackmount	2	24	370 W	47
560559	Yes	Gigabit	24	2 SFP Ports	Yes	Rackmount	2	24	240 W	48
561426	Yes	Gigabit	24	4 Gigabit Combo Base-T/SFP Ports	Yes	Rackmount	2	24	370 W	48
561587	Yes	Gigabit	48	4 x 10 GbE SFP+ Uplink Ports	Yes	Rackmount	4	48	400 W	48

## OUR FLAGSHIP SWITCH

# 48-Port Gigabit PoE+ Layer2+/ Layer 3 Lite

**NEW**

Managed, Four 10G SFP+ Uplinks, 400 W

**demotz**  
compatible

[561587]



Check it out on page 48



Great networks need IT professionals, installers and integrators who can see and respond to what’s happening at any time.

That’s why our managed switches are now compatible with Domotz Pro, the premier platform in Remote Network Monitoring and Management. Intellinet Network Solutions managed switches and Domotz help network professionals monitor and manage every endpoint to proactively prevent connectivity issues and solve problems in real time – anytime, anywhere.

**FEATURES:**

- VPN on Demand, for troubleshooting and remote monitoring
- Secure remote connection via app or web
- Create customizable alerts for email and mobile devices
- Change device configurations and system programming
- Troubleshoot issues and resolve problems
- Power cycle devices and initiate reboots
- Complete maintenance and perform upgrades; and much more

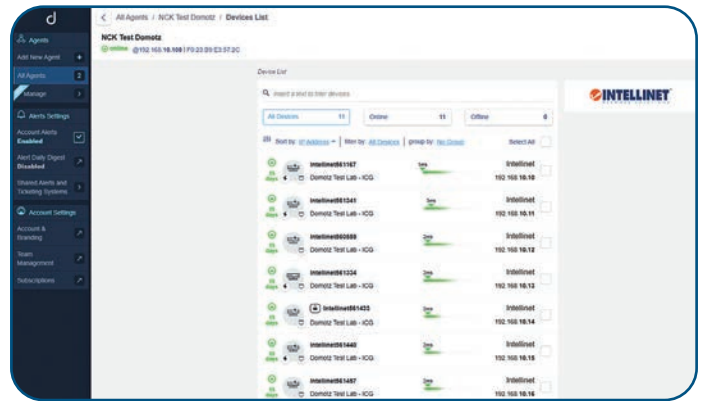
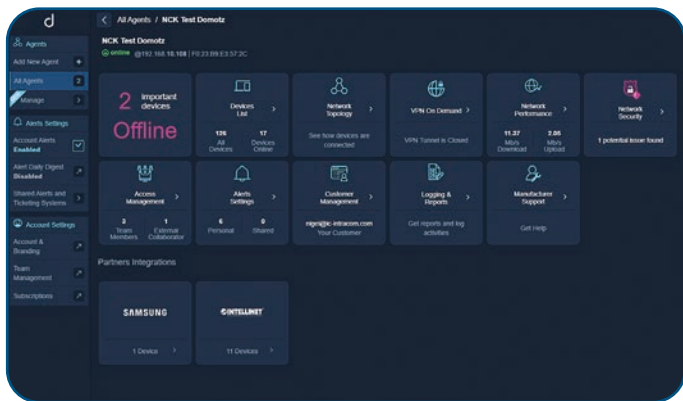

Web Interface

**NEW**



**Domotz Pro Box**

[561631] Unified System for Remote Monitoring and Cloud Management of Networks and IP Devices

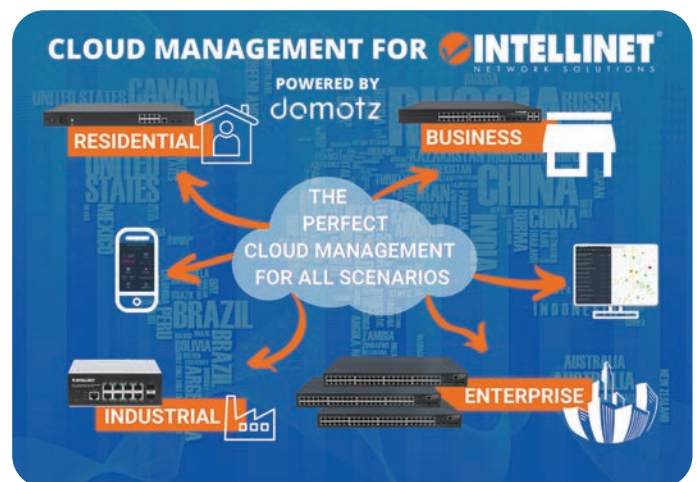

Look for this icon with our switches.

**Learn more on [intellinetnetwork.eu/cloud](http://intellinetnetwork.eu/cloud)**



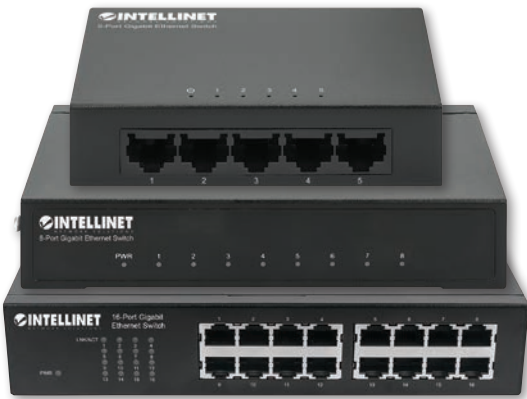

### Gigabit Ethernet Switch

- [\[530378\]](#) 5-Port
- [\[530347\]](#) 8-Port
- [\[561068\]](#) 16-Port
- [\[561815\]](#) 16-Port

RJ45 10/100/1000 Mbps, IEEE 802.3az Energy Efficient Ethernet

- 10/100/1000 auto-sensing ports automatically detect optimal network speeds
- All RJ45 ports with Auto-MDIX (auto uplink) support



### 24-Port Gigabit Ethernet Switch with 2 SFP Ports

[\[561044\]](#) 24 x 10/100/1000 Mbps RJ45 Ports + 2 x SFP, IEEE 802.3az (Energy Efficient Ethernet), 19" Rackmount, Metal

- 10/100/1000 auto-sensing ports automatically detect optimal network speeds
- Two small form-factor pluggable GBIC module slots (SFP)
- Supports 802.3x flow control for full duplex mode and collision-based backpressure for half duplex mode
- 52 Gbps switch fabric
- Supports up to 8K MAC address entries



### 24-Port Gigabit Ethernet Switch

[\[561273\]](#) 24 x 10/100/1000 Mbps RJ45 Ports, IEEE 802.3az Energy Efficient Ethernet, Desktop, 19" Rackmount

- Auto-MDIX (auto uplink) support for all RJ45 ports
- Supports 802.3x flow control for full duplex mode and collision-based backpressure for half duplex mode
- 48 Gbps switch fabric
- Supports 16k MAC address entries
- 512 kBytes buffer memory



**NEW**

### 6-Port Fast Ethernet Switch with 4 PoE Ports (1 x High-Power PoE)

[\[561686\]](#) One High-Power 60 W PSE PoE Port, Three IEEE 802.3at/af PSE PoE Ports, PoE Power Budget of 65 W, PoE Extend Mode, Two RJ45 Uplink Ports, VLAN

- Provides up to four PoE network devices with power and data
- Manual PoE extend mode (reduces network speed and extends PoE support to 250 m/820 ft.)
- One high-power PSE PoE Port with power up to 60 W, three IEEE 802.3at/af PSE PoE Ports with up to 30 W each
- PoE power budget of 65 watts
- Two RJ45 Fast Ethernet uplink ports



### 8-Port Fast Ethernet PoE+ Switch

[\[561075\]](#) 4 x PoE IEEE 802.3at/af Power-over-Ethernet (PoE+/PoE) ports, 4 x Standard RJ45 Ports, Endspan, Desktop, 19" Rackmount

- Four IEEE 802.3at/af-compliant RJ45 PoE/PoE+ output ports
- PoE power budget of 70 watts
- Supports up to 2K MAC address entries
- 768 kBytes buffer memory
- Desktop-size metal case
- Includes 19" rackmount brackets



### 8-Port Fast Ethernet PoE+ Switch

**[560764]** 8 x PoE ports, IEEE 802.3at/af Power-over-Ethernet (PoE+/PoE), Endspan, Desktop

- Power output up to 30 watts per port
- PoE power budget of 140 watts
- 10/100 Mbps auto-sensing ports automatically detect optimal network speeds



### 8-Port Gigabit Ethernet PoE+ Switch

**[561204]** IEEE 802.3at/af Power over Ethernet (PoE+/PoE) Compliant, 60 W, Desktop

- Provides power and data connection for up to eight PoE network devices
- 10/100/1000 auto-sensing ports automatically detect optimal network speeds
- Provides private VLAN (port isolation) functionality
- Total power budget of 60 watts
- 16 Gbps switch fabric
- Desktop-size metal case



### 8-Port Gigabit Ethernet PoE+ Switch

**[560641]** IEEE 802.3at/af Power over Ethernet (PoE+/PoE) Compliant, 140 W, Endspan, Desktop, 19" Rackmount

- Provides power and data connection for up to eight PoE network devices
- 10/100/1000 auto-sensing ports automatically detect optimal network speeds
- PoE power budget of 140 watts
- Power output up to 30 watts per port\*
- 4 kV surge protection for PoE ports



### 5-Port Gigabit Ethernet PoE+ Switch

**[561228]** 4 x PSE Ports, IEEE 802.3at/af Power over Ethernet (PoE+/PoE) Compliant, 60 W, Desktop

- Power output up to 30 watts per port
- PoE power budget of 60 watts
- All RJ45 ports equipped with Auto-MDIX and auto-negotiation support
- Complies with the IEEE 802.3az (Energy Efficient Ethernet EEE) specification
- 10 Gbps switch fabric
- Supports jumbo frames up to 9 kBytes



### 5-Port Gigabit Ethernet PoE+ Switch with SFP Combo Port

**[561174]** 4 x PSE Ports, IEEE 802.3at/af Power over Ethernet (PoE+/PoE) Compliant, 80 W, Desktop

- Four 10/100/1000 Mbps IEEE 802.3at/af-compliant RJ45 PoE ports; one gigabit combo RJ45/SFP port
- Power output up to 30 watts per port
- PoE power budget of 80 watts
- All RJ45 ports equipped with Auto-MDIX and auto-negotiation support
- 10 Gbps switch fabric
- Supports jumbo frames up to 9 kBytes

**NEW**



### 8-Port Gigabit Ethernet PoE+ Switch with 2 RJ45 Gigabit Uplink Ports

**[561402]** IEEE 802.3at/af Power over Ethernet (PoE+/PoE) Compliant, 120 W, Endspan, Desktop

- Manual PoE extend mode (reduces network speed and extends PoE support to 250 m)
- PoE power budget of 120 watts
- Two RJ45 Gigabit uplink ports
- 10 Gbps switch fabric
- Manual VLAN mode (allows ports 1 through 8 to be isolated from each other)



### 8-Port Gigabit Ethernet PoE+ Web-Managed Switch with 2 SFP Ports

**[561167]** IEEE 802.3at/af Power over Ethernet (PoE+/PoE) Compliant, 140 W, Endspan, Desktop, 19" Rackmount

- PoE power budget of 140 watts
- 20 Gbps switch fabric
- Configuration via Web browser, Telnet or SSH
- Supports SNMP management
- IGMP Snooping for multicast filtering
- Supports VLAN (tag-based and port-based)



### 16-Port Gigabit Ethernet PoE+ Switch

**[560993]** 16 x PoE ports, IEEE 802.3at/af Power over Ethernet (PoE+/PoE), Endspan, Rackmount

- Power output up to 30 watts per port\*
- PoE power budget of 220 watts
- All RJ45 ports with Auto-MDIX (auto uplink) support
- IEEE 802.3x flow control for full duplex
- Supports up to 8192 MAC address entries
- 256 kBytes buffer memory



### 16-Port Gigabit Ethernet PoE+ Web-Managed Switch with 2 SFP Ports

**[561341]** 220 W PoE Power Budget

**[561198]** 374 W PoE Power Budget

IEEE 802.3at/af Power over Ethernet (PoE+/PoE) Compliant, Endspan, 19" Rackmount

- Two small form-factor pluggable GBIC module slots (SFP)
- 36 Gbps switch fabric
- SNMP Management and Remote Monitoring (RMON)
- Supports VLAN (tag-based and port-based)
- Supports two types of QoS: port-based and DSCP



### 16-Port Gigabit Ethernet PoE+ Switch with 2 SFP Ports and LCD Screen

**[561259]** LCD Display, IEEE 802.3at/af Power over Ethernet (PoE+/PoE) Compliant, 370 W, Endspan, 19" Rackmount

- 10/100/1000 auto-sensing ports automatically detect optimal network speeds
- LCD display for easy access to real-time PoE status monitoring
- PoE power budget of 370 watts
- Two small form-factor pluggable GBIC module slots (SFP)
- 36 Gbps switch fabric
- Supports up to 8192 MAC address entries



### 16-Port Gigabit Ethernet PoE+ Switch with 4 RJ45 Gigabit and 2 SFP Uplink Ports

**[561419]** IEEE 802.3at/af Power over Ethernet (PoE+/PoE) Compliant, 300 W, Endspan, 19" Rackmount

- Manual PoE extend mode (reduces network speed and extends PoE support to 250 m)
- PoE power budget of 300 watts
- Four RJ45 Gigabit and two SFP uplink ports
- Manual VLAN mode (allows ports 1 through 16 to be isolated from each other)
- 36 Gbps switch fabric



### 24-Port Gigabit Ethernet PoE+ Switch with 2 SFP Ports and LCD Screen

**[561242]** LCD Display, IEEE 802.3at/af Power over Ethernet (PoE+/PoE) Compliant, 370 W, Endspan, 19" Rackmount

- LCD display for easy access to real-time PoE status monitoring
- PoE power budget of 370 watts
- Two small form-factor pluggable GBIC module slots (SFP)
- 52 Gbps switch fabric





### 24-Port Gigabit Ethernet PoE+ Web-Managed Switch with 2 SFP Ports

**[560559]** 24 x PoE ports, IEEE 802.3at/af Power over Ethernet (PoE+/PoE), 2 x SFP, Endspan, 19" Rackmount

- 10/100/1000 auto-sensing ports automatically detect optimal network speeds
- Two small form-factor pluggable GBIC module slots (SFP)
- Power output up to 30 watts per port
- PoE power budget of 240 watts
- 52 Gbps switch fabric
- Supports SNMP management
- Supports VLAN (tag-based and port-based)
- Supports link aggregation (trunking)
- IGMP Snooping for multicast filtering
- Supports two types of QoS: port-based and DSCP



### 24-Port Gigabit Ethernet PoE+ Web-Managed Switch with 4 Gigabit Combo Base-T/SFP Ports

**[561426]** IEEE 802.3at/af Power over Ethernet (PoE+/PoE) Compliant, 370 W, Endspan, 19" Rackmount

- 10/100/1000 Mbps auto-sensing ports automatically detect optimal network speeds
- Four combo small-form-factor pluggable GBIC module slots (SFP) and four RJ45 copper uplinks
- PoE power budget of 370 watts
- 56 Gbps switch fabric
- Supports SNMP management
- Supports VLAN (tag-based and port-based)
- Supports link aggregation (trunking)
- IGMP Snooping for multicast filtering
- Supports two types of QoS: IEEE 802.1p and DSCP

## OUR FLAGSHIP SWITCH

# 48-Port Gigabit PoE+ Layer2+/ Layer 3 Lite

Managed, Four 10G SFP+ Uplinks, 400 W

**[561587]**



- Power output up to 30 watts per port
- Supports IEEE 802.3at/af detection and short circuit, overload and high-voltage protection
- Supports VLAN (tag-based and port-based)
- Switch fabric of 176 Gbps
- SNMP Management and Remote Monitoring (RMON)
- Supports link aggregation (trunking)
- IGMP Snooping for multicast filtering
- Supports two types of QoS: port-based and DSCP

- Supports 16k MAC address entries
- Complies with the IEEE 802.3az (Energy Efficient Ethernet EEE) specification
- IPv4/v6 dual protocol
- Supports bandwidth control per port
- Supports port mirroring
- Supports jumbo frames up to 10 kBytes
- IEEE 802.3x flow control for full duplex
- Configuration via Web browser or RJ45 console port
- Two high-volume cooling fans to ensure perfect ventilation



Rackmount



4 x 10 G  
SFP+ Open Slots

**400**  
WATTS

Power Budget

**48**

PoE Devices  
Supported



# Hardened Switches for Rough, Industrial Environments

**IP40**

IP40-rated metal housing with shock and vibration resistance

**DIN**

DIN-rail mounting option



Suitable for extreme operating temperatures of -40 to 75°C



Two safe redundant DC power inputs with power failure alarm



**NEW**

## 4-Port Gigabit Ethernet Industrial Switch with 2 SFP Ports

[508247] IP40-Rated Metal Housing, DIN-Rail Mount

- Two small form-factor pluggable GBIC module slots (SFP)
- Supports jumbo frames up to 9.6 kBytes Port
- Surge protection up to 6 kV



**NEW**

## Gigabit Ethernet PoE+ Industrial Switch with 2 SFP Ports

[508254] 4-Port, Power Budget up to 120 W

[508261] 8-Port, Power Budget up to 240 W IEEE 802.3at/af (PoE+/PoE) Compliant, IP40-Rated Metal Housing, Endspan, DIN-Rail Mount

- Two small form-factor pluggable GBIC module slots (SFP)
- Power output up to 30 watts per port
- PoE power budget depending on the power supply used
- Port surge protection up to 6 kV



**NEW**

## 8-Port Gigabit Ethernet PoE+ Switch with PoE Passthrough

[561624] One PD PoE Port with 95 W Power Input, Seven PSE PoE Ports, PoE Power Budget up to 120 W, IEEE 802.3at/af Compliant, DIN-Rail Mount

- Supports up to 95 W power input from a PoE injector or switch
- Doubles the connection distance between PoE source and device from 100 m (328 ft.) to 200 m (656 ft.)
- Powered via PoE, DC power adapter or industrial power supply (not included)
- PoE power budget up to 120 watts (depending on the power supply used)



**NEW**



## 8-Port Gigabit Ethernet PoE+ Web-Managed Industrial Switch with 2 SFP Ports

[508278] IEEE 802.3at/af (PoE+/PoE) Compliant, PoE Power Budget up to 240 W, IP30-Rated Metal Housing, Endspan, DIN-Rail Mount

- Two small form-factor pluggable GBIC module slots (SFP)
- Power output up to 30 watts per port
- PoE power budget of 240 watts (depending on the power supply used)
- Port surge protection up to 6 kV

Check out our Industrial Injectors and Media Converters on the following pages



# Get the Most out of each PoE Connection with PoE Passthrough

## SAMPLE CONFIGURATION:

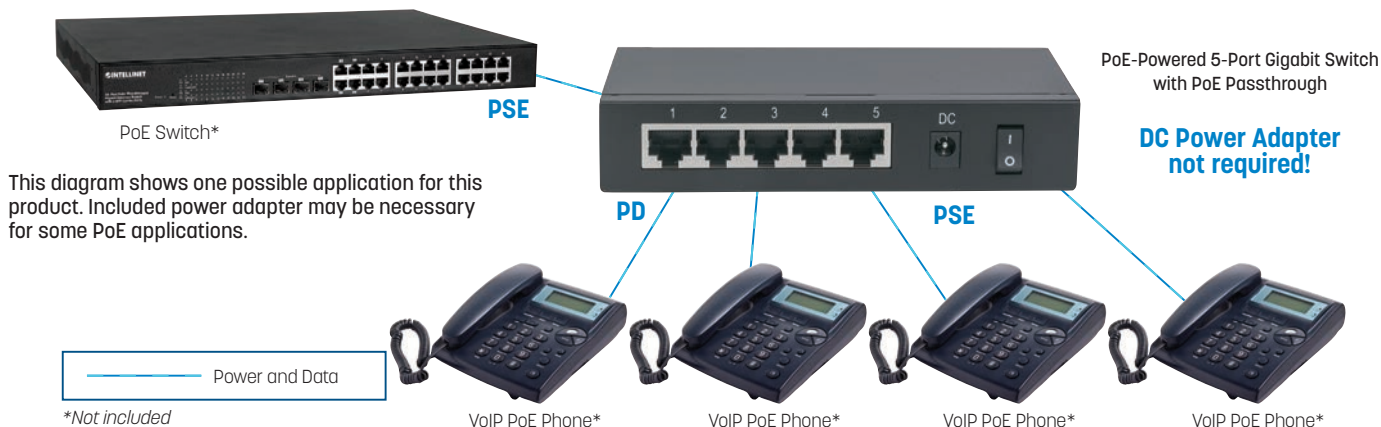

Double the connection distance between your PoE source and device from 100 m to 200 m  
 Save time and money by delivering data and power via existing network cables

## PoE-Powered 5-Port Gigabit Switch with PoE Passthrough

### FEATURES:

- Can receive power from a PoE injector or PoE switch and provides up to four PoE network devices with power and data
- Total power budget of 68 watts when using AC power
- Total power budget when powered via PD input port: 26 W (#561082) / 65 W (#561808)
- Power output up to 30 Watts per port



Model # 561082 (PoE+ Input) / # 561808 (PoE++ Input)

## PoE-Powered 8-Port Gigabit Ethernet PoE+ Switch with PoE Passthrough

### FEATURES:

- Supports up to 90 W power input from a PoE injector or switch and provides up to seven PoE network devices with power and data
- PoE power budget of 85 W with 90 W power input through IEEE 802.3bt connection
- PoE power budget of 20 W through IEEE 802.3at connection and 10 W through IEEE 802.3af connection
- Power output up to 30 watts per port



Model # 561679

## PoE-Powered 8-Port Gigabit Ethernet PoE+ Industrial Switch with PoE Passthrough

### FEATURES:

- Supports up to 95 W power input from a PoE injector or switch and provides up to seven PoE network devices with power and data
- Powered via PoE, DC power adapter or industrial power supply (no power supply included)
- PoE power budget up to 120 watts (depending on the power supply used)
- Power output up to 30 watts per port
- Two redundant DC inputs (48 – 57 V) with I/O terminal block
- Option for DIN-rail installation



Model # 561624

# Access Point + AP Management Controller

## Your Wireless Dream Team

NEW



NEW



### Manageable Wireless AC1300 Dual-Band Gigabit PoE Indoor Access Point and Router

**[525831]** Wireless AC (5 GHz) up to 867 Mbps + Wireless N (2.4 GHz) up to 450 Mbps, WDS, Wireless Client Isolation, Mountable to Desktop, Wall or Ceiling

- Ultra-fast data transfer rate up to 1.3 Gbps in simultaneous dual-band operation
- Modern IEEE 802.11ac Wave 2 technology for a major boost in network efficiency
- Delivers up to 867 Mbps on 5-GHz band and 450 Mbps on 2.4-GHz band
- MU-MIMO technology to increase speed and throughput for multiple devices at once
- Wireless Client Isolation for additional security
- Three Gigabit Ethernet ports for super-fast wired connections
- Supported modes: Access Point, Router, WDS
- PoE-enabled; no need to install near a traditional power source

### Wireless Access Point Management Controller

**[525749]** Manages up to 200 Access Points, Built-in Router Feature With One WAN Port, 19" Rackmountable

- Conveniently manages up to 200 access points (AP) from one centralized controller
- Compatible with Intellinet Network Solutions Manageable Wireless AC1300 Dual-Band Gigabit PoE Access Point and Router (see model #525831)
- Manages APs with upgrade, reboot, reset, configuration and removal options
- Creates individual configuration templates to apply to several APs in batch setups
- Router functionality with one Gigabit WAN port
- One USB 2.0 port to use in FTP server applications
- VPN server and client support

### High-Power Wireless AC600 Dual-Band Outdoor Access Point and Repeater

**[525824]** 433 Mbps Wireless AC (5 GHz) + 150 Mbps Wireless N (2.4 GHz), IP65, 28 dBm, Wireless Client Isolation, Passive PoE, Wall- and Pole-mount

- Delivers up to 433 Mbps (5 GHz) and 150 Mbps (2.4 GHz) speeds
- Weatherproof and corrosion resistant, IP65
- Simultaneous dual-band operation (2.4 GHz and 5 GHz) provides twice the bandwidth
- Powerful 7 dBi gain antennas, detachable, with RP-SMA female connector
- Supported modes: Access Point, Router, Repeater and WISP (Wireless ISP)
- Included passive POE injector for up to 60 meters (200 feet) connection distance

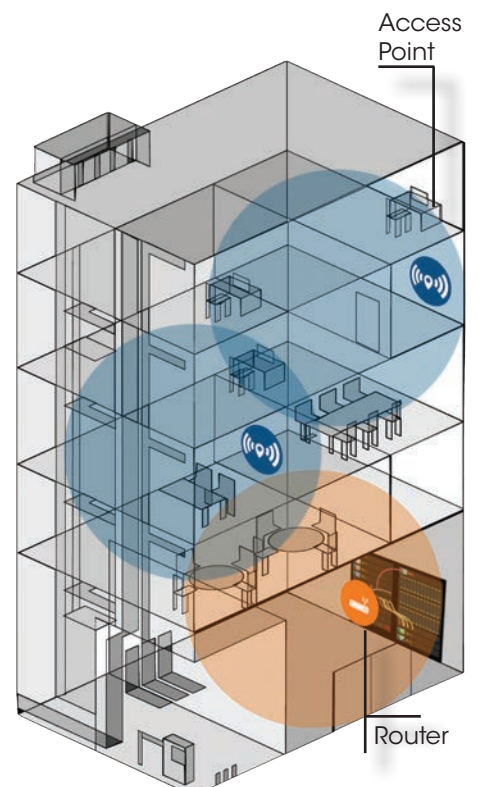



# Compatible with Cisco, HPE and many more



Our Transceiver Modules are either HPE- or MSA-compliant and therefore designed, programmed and tested to work with Intellinet Network Solutions, but also compatible switches and routers from Cisco, HPE, ZyXEL, TP-Link, Ubiquiti, D-Link and many more. For all compatible brands, please check [intellinetnetwork.com](http://intellinetnetwork.com).

**Modules for Juniper, Huawei and Arista available for immediate shipment.**

## MSA-compliant models

	Model #	Speed	Distance	Note	Form Factor	Wavelength	Interface	Medium
	523882	1G	100 m		SFP	-	RJ45	Copper
	545006	1G	550 m		SFP	850 nm	LC	MMF
<b>NEW</b>	508551	1G	550 m	Industrial Grade	SFP	850 nm	LC	MMF
	545013	1G	10 km		SFP	1310 nm	LC	SMF
	507486	1G	10 km	WDM BiDi, use with #507509	SFP	1310/1550 nm	LC	SMF
	507509	1G	10 km	WDM BiDi, use with #507486	SFP	1550/1310 nm	LC	SMF
<b>NEW</b>	508568	1G	10 km	Industrial Grade	SFP	1310 nm	LC	SMF
	506724	1G	20 km		SFP	1310 nm	LC	SMF
<b>NEW</b>	508599	1G	40 km	WDM BiDi, use with #508582	SFP	1310/1550 nm	LC	SMF
<b>NEW</b>	508582	1G	40 km	WDM BiDi, use with #508599	SFP	1550/1310 nm	LC	SMF
<b>NEW</b>	508629	1G	80 km	WDM BiDi, use with #508797	SFP	1490/1550 nm	LC	SMF
<b>NEW</b>	508797	1G	80 km	WDM BiDi, use with #508629	SFP	1550/1490 nm	LC	SMF
<b>NEW</b>	508650	1G	120 km	WDM BiDi, use with #508643	SFP	1490/1550 nm	LC	SMF
<b>NEW</b>	508643	1G	120 km	WDM BiDi, use with #508650	SFP	1550/1490 nm	LC	SMF
	508179	10G	30 m		SFP+	-	RJ45	Copper
<b>NEW</b>	508674	10G	220 m		SFP+	1310 nm	LC	MMF
	507462	10G	300 m		SFP+	850 nm	LC	MMF
<b>NEW</b>	508667	10G	300 m	Industrial Grade	SFP+	850 nm	LC	MMF
<b>NEW</b>	508698	10G	300 m		XFP	850 nm	LC	MMF
	507479	10G	10 km		SFP+	1310 nm	LC	SMF
<b>NEW</b>	508681	10G	10 km	Industrial Grade	SFP+	1310 nm	LC	SMF
<b>NEW</b>	508704	10G	10 km		XFP	1310 nm	LC	SMF

## HPE-compliant models

	Model #	Speed	Distance	Note	Form Factor	Wavelength	Interface	Medium
<b>NEW</b>	508766	10G	300 m		SFP+	850 nm	LC	MMF
<b>NEW</b>	508742	1G	550 m		SFP	850 nm	LC	MMF
<b>NEW</b>	508735	1G	10 km		SFP	1310 nm	LC	SMF
<b>NEW</b>	508773	1G	10 km	WDM BiDi, use with #508780	SFP	1310/1550 nm	LC	SMF
<b>NEW</b>	508780	1G	10 km	WDM BiDi, use with #508773	SFP	1550/1310 nm	LC	SMF
<b>NEW</b>	508759	10G	10 km		SFP+	1310 nm	LC	SMF



# For Uplink Connectivity and System Management

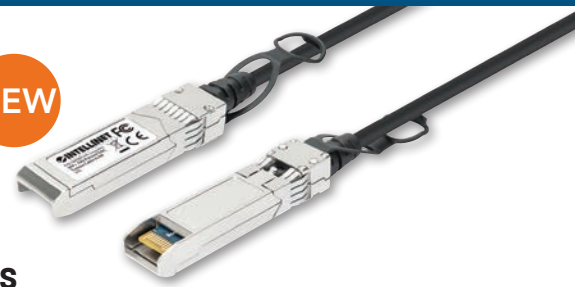

## The benefits of DAC cables over fiber optic and RJ45 cables

The Direct Attach Copper (DAC) cable is becoming increasingly popular in the network industry. Our passive SFP+ and QSFP+ twinax cables are an energy-efficient, low-latency and cost-effective alternative to fiber optic and RJ45 cabling. It's an excellent choice for short-distance structured cabling between switches and routers on one end and servers or storage on the other, be it in Top of Rack (ToR), adjacent rack, stacking of 10GbE switches or similar applications.

### Close to zero power consumption and a wide temperature range

DAC is comprised of a twinax copper cable terminated with SFP+ or QSFP+ connectors on both ends, which can provide an electrical connection directly into active equipment. Consuming less than 0.15 W due to its thermal design, this passive cable helps decrease your operating expenses. Its zero-heat production during operation makes it more versatile and usable in wider temperature ranges up to 70°C (158°F), which is particularly valuable in data centers.

### Lower cost and simpler to deploy than fiber optics

DAC cabling has a relatively simple internal structure with fewer components than fiber cables. This cable structure helps lower the purchase price for applications in high-bandwidth data transmission and saves you from having to buy separate transceivers. This, in turn, makes DAC cables a lot simpler to deploy since there are fewer parts to match to complete setup. When you make upgrades or replacements to your network, the cable's seamless Hot Swapping capability makes quick work of connecting new equipment (note that passive DAC cables are not suitable for long-range applications; at 7 m (23 ft.), they reach their transmission limit).

### Lower latency than RJ45 twisted-pair patch cables

This Direct Attach Copper twinax cable supports data transfer rates up to 40 Gbps, and its unique structure and signal transmission offers lower latency.

### Compatible with Cisco, HPE and many more

Our DAC twinax cables are either HPE- or MSA-compliant and therefore designed, programmed and tested to work with IntelNet Network Solutions, but also compatible switches and routers from Cisco, HPE, ZyXEL, TP-Link, Ubiquiti, D-Link and many more. For all compatible brands, please check [intellinetnetwork.com](http://intellinetnetwork.com).

## MSA-compliant models

Model #	Length	Form Factor	Speed	Compatibility
508377	0.5 m	SFP+	10 Gbps	MSA
508490	0.5 m	QSFP+	40 Gbps	MSA
508391	1 m	SFP+	10 Gbps	MSA
508506	1 m	QSFP+	40 Gbps	MSA
508414	2 m	SFP+	10 Gbps	MSA
508513	2 m	QSFP+	40 Gbps	MSA
508438	3 m	SFP+	10 Gbps	MSA
508537	3 m	QSFP+	40 Gbps	MSA
508452	5 m	SFP+	10 Gbps	MSA

## HPE-compliant models

Model #	Length	Form Factor	Speed	Compatibility
508384	0.5 m	SFP+	10 Gbps	HPE
508407	1 m	SFP+	10 Gbps	HPE
508421	2 m	SFP+	10 Gbps	HPE
508445	3 m	SFP+	10 Gbps	HPE
508483	5 m	SFP+	10 Gbps	HPE

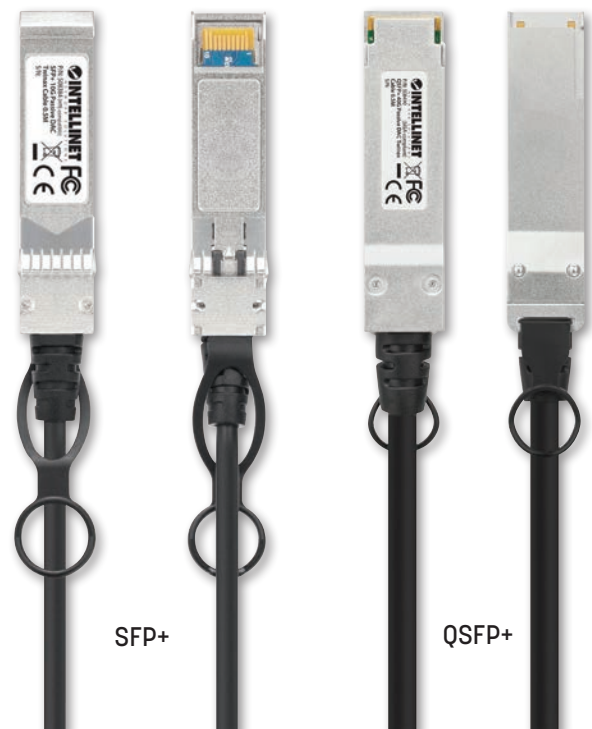

Model #	Product Type	Speed	Ports	Power Output per Port	PoE Standards	Housing
524179	PoE Injector	Fast Ethernet	1	15.4 W	IEEE 802.3af	Plastic
561518	PoE Injector	Gigabit	1	30 W	IEEE 802.3at/af	Plastic
560566	PoE Injector	Gigabit	1	30 W	IEEE 802.3at/af	Metal
561365	PoE Injector	Gigabit	1	30 W	IEEE 802.3at/af	Industrial
561495	PoE Injector	Gigabit	1	95 W	IEEE 802.3bt/at/af	Plastic
561488	PoE Injector	Gigabit	2	1 x 50 W, 1 x 30 W	IEEE 802.3bt/at/af	Plastic
561235	PoE Injector	Gigabit	1	60 W	IEEE 802.3at/af	Plastic
561778	PoE Injector	Gigabit	1	30 W	IEEE 802.3at/af	Outdoor
561785	PoE Injector	Gigabit	1	60 W	IEEE 802.3bt/at/af	Outdoor
720342	PoE Patch Panel	Gigabit	24	30	IEEE 802.3at/af	Metal
561693	PoE Splitter	Gigabit	1	45 W USB-C	IEEE 802.3bt/at/af	Plastic
560443	PoE Splitter	Fast Ethernet	1	5, 7.5, 9 or 12 V DC	IEEE 802.3at/af	Metal
560962	PoE Extender	Gigabit	1	30 W	IEEE 802.3at/af	Metal
561266	PoE Extender	Gigabit	2	30 W	IEEE 802.3at/af	Metal
561600	PoE Extender	Gigabit	2	60 W	IEEE 802.3bt/at/af	Metal
561617	PoE Extender	Gigabit	4	90 W	IEEE 802.3bt/at/af	Metal
508209	PoE Injector & Media Converter	Gigabit	1	30 W	IEEE 802.3at/af	Metal
508216	PoE Injector & Media Converter	Gigabit	1	30 W	IEEE 802.3at/af	Metal

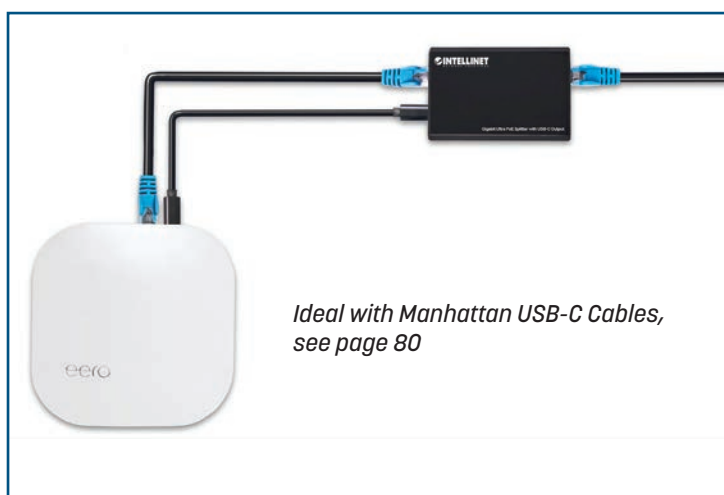

Split a PoE connection into 45 W USB-C power and Gigabit RJ45 speeds

**NEW**



**Gigabit Ultra PoE Splitter with USB-C Output**  
[\[561693\]](#) IEEE 802.3bt/at/af Compliant, RJ45 In and Out Ports, Up to 45 W USB-C Output Port, Plastic Housing

**Cost-effective, passive Power-over-Ethernet upgrade for your network**

**12-Port Passive PoE Patch Panel**

[\[720342\]](#) 24-Port Patch Panel with 12 port RJ45 Data In and 12 port RJ45 Data and Power Out, 120 W Power Budget, Up To 30 W Output per Port, Power Adapter Included, Metal Construction

**SAMPLE CONFIGURATION:**

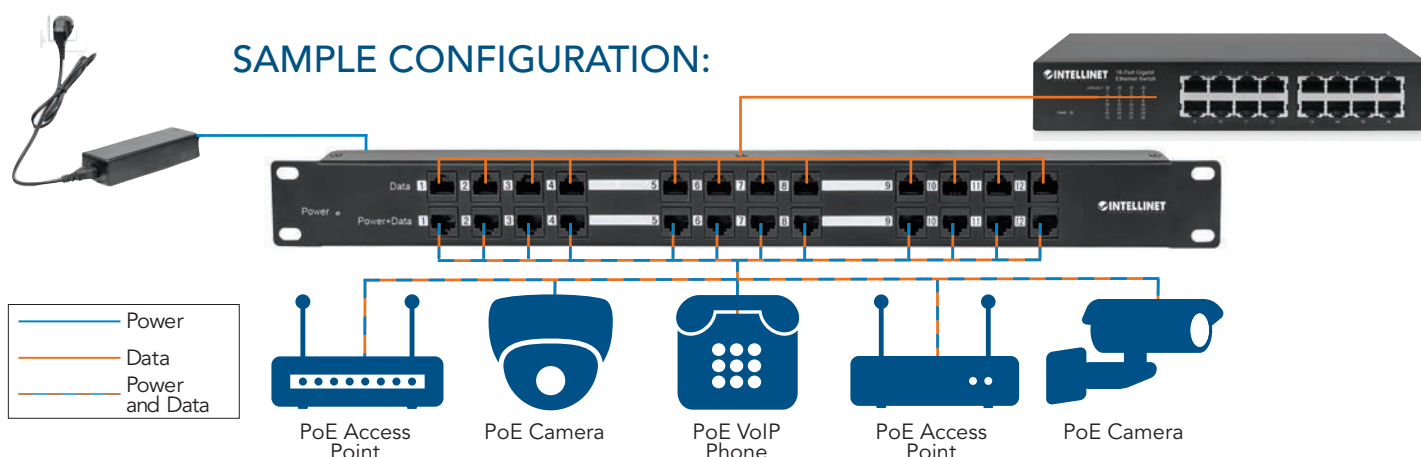



**Fast Ethernet PoE+ Splitter**

- Splits into RJ45 data and 5, 7.5, 9 or 12 V DC
  - IEEE 802.3at/af
  - Metal housing
- [560443]



**Fast Ethernet PoE Injector**

- 1 x 15.4 W port
  - IEEE 802.3af
  - Plastic housing
- [524179]



**Gigabit PoE+ Injector**

- 1 x 30 W port
  - IEEE 802.3at/af
  - Plastic housing
- [561518]



**Gigabit PoE+ Injector**

- 1 x 30 W port
  - IEEE 802.3at/af
  - Metal housing
- [560566]



**Gigabit PoE+ Injector**

- 1 x 30 W port
  - IEEE 802.3at/af
  - IP30 Industrial housing with DIN rail installation option
- [561365]



**Gigabit Ultra PoE Injector**

- 1 x 60 W port
  - IEEE 802.3at/af
  - Plastic housing
- [561235]



**Gigabit Ultra PoE Injector**

- 1 x 95 W port
  - IEEE 802.3bt/at/af
  - Plastic housing
- [561495]



**2-Port Gigabit Ultra PoE Injector**

- 1 x 50 W, 1 x 30 W port
  - IEEE 802.3at/af
  - Plastic housing
- [561488]



**Outdoor Vandalproof Gigabit PoE+ Injector**

- 1 x 30 W port
  - IEEE 802.3at/af
  - IP67 & IK10 metal housing
- [561778]



**Outdoor Vandalproof Gigabit Ultra PoE Injector**

- 1 x 60 W port
  - IEEE 802.3bt/at/af
  - IP67 & IK10 metal housing
- [561785]





### 2-Port Outdoor Vandalproof Gigabit Ultra PoE Extender/ Repeater

Adds up to 100 m (328 ft.) to PoE Range, Two 30 W Ports, 60 W Power Budget, IEEE 802.3bt/at/af Compliant, IP67 Waterproof, IK10-rated, Metal Housing

- Functional as a PoE-powered 3-port Gigabit switch with PoE passthrough
- Requires no additional power supply; draws power directly from the PoE input
- IP67-rated, dustproof and waterproof plus IK10-rated, vandal-proof

[561648]



- IP67 Weather-Proof
- 60 Watts Power Budget



Ultra PoE Switch

**EXTENDS UP TO 200 M**



2-Port Ultra PoE Extender

100 m.  
30 W

PoE PTZ Camera

100 m.  
30 W

PoE PTZ Camera



- 25 Watts Power Budget
- IP65 Weather-Proof
- Daisy-Chainable

### Outdoor Gigabit High-Power PoE+ Extender/Repeater

Water and dust proof with IP65 Rating, IEEE 802.3at/af compliant, Aluminum Case

- Can daisy-chain up to four POE extenders for a distance of up to 500 M
- **Requires no additional power supply; Each unit draws 4 Watts of power directly from the Main POE+ Switch or 30W Injector**
- Mounting holes allow you to quickly mount to any wall or ceiling
- Water tight ends seal and protect

[561211]

**EXTENDS UP TO 500 M**

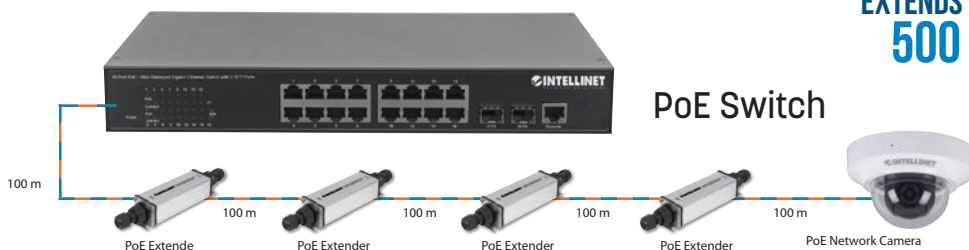

PoE Switch

PoE Extende

PoE Extender

PoE Extender

PoE Extender

PoE Network Camera

### 4-Port Gigabit Ultra PoE Extender/ Repeater

Adds up to 100 m (328 ft.) to PoE Range, 90 W PoE Power Budget, Four PSE Ports with up to 30 W Output, IEEE 802.3bt/at/af Compliant, Metal Housing

- Functional as a PoE-powered 5-Port Gigabit Switch with PoE passthrough
- Requires no additional power supply; draws power directly from the PoE input
- PoE awareness ensuring that power is only sent to IEEE 802.3at/af-compliant devices; non-PoE devices only receive data

[561617]



- 90 Watts Power Budget



Ultra PoE Switch

**EXTENDS UP TO 200 M**



4-Port Ultra PoE Extender

100 m  
30 W

PoE PTZ Camera

100 m  
30 W

PoE PTZ Camera

100 m  
15 W

PoE Dome Camera

100 m  
15 W

PoE Dome Camera

PoE Dome Camera



### 2-Port Gigabit Ultra PoE Extender/Repeater

Adds up to 100 m (328 ft.) to PoE Range, PoE Power Budget 60 W, Two PSE Ports with 30 W Output Each, IEEE 802.3bt/at/af Compliant, Metal Housing

- Functional as a PoE-powered 3-port Gigabit switch with PoE passthrough
- Requires no additional power supply; draws power directly from the PoE input
- PoE awareness ensuring that power is only sent to IEEE 802.3at/af-compliant devices; non-PoE devices only receive data

[561600]



Ultra PoE Switch

100 m  
60 W

**EXTENDS UP TO  
200 M**



2-Port Ultra PoE Extender

100 m  
30 W  
100 m  
30 W

PoE PTZ Camera

PoE PTZ Camera



**60 Watts** Power Budget

**NEW**



**25 Watts** Power Budget

100 m

100 m

100 m



PoE Network Camera

PoE Network Camera



PoE Switch

**EXTENDS UP TO  
200 M**

### 2-Port Gigabit High-Power PoE+ Extender/Repeater

2 Port Extender/Repeater, IEEE 802.3at/af Compliant Range Extender, 100 m Additional Range for 2 Ports, Metal

- Connects and powers two PoE devices such as network cameras, Wireless Access Points or VoIP phones from one PoE injector or PoE switch PSE port
- Allows you to double the connection distance between PoE source and device from 100 m to 200 m
- Requires no additional power supply; draws 4 Watts of power directly from the PoE+ Switch or PoE 30W Injector which leaves you with 26 watts to share for 2 PoE Devices

[561266]



**25 Watts** Power Budget

Daisy-Chainable

### Gigabit High-Power PoE+ Extender/Repeater

Indoor POE+ Extender/Repeater solution, IEEE 802.3at/af compliant, Metal Case

- Can daisy-chain up to five POE extenders for a distance of up to 600 M
- **Requires no additional power supply; Each unit draws 4 Watts of power directly from the Main PoE+ Switch or 30W Injector**
- LEDs show PoE and data activity
- Mounting holes allow you to quickly mount to any wall or ceiling

[560962]

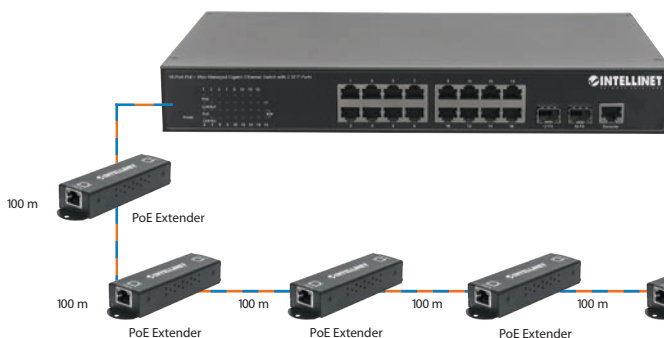

PoE Switch

**EXTENDS UP TO  
600 M**

Model #	Speed	Distance	Note	Conversion	Wavelength	Mode
506502	Fast Ethernet	2 km		10/100Base-TX to 100Base-FX (SC)	1310 nm	MM
506519	Fast Ethernet	2 km		10/100Base-TX to 100Base-FX (ST)	1310 nm	MM
507332	Fast Ethernet	20 km		10/100Base-TX to 100Base-FX (SC)	1310 nm	SM
510530	Fast Ethernet	20 km	WDM BiDi, use with #510547	10/100Base-TX to 100Base-FX (SC)	1310/1550 nm	SM
510547	Fast Ethernet	20 km	WDM BiDi, use with #510530	10/100Base-TX to 100Base-FX (SC)	1550/1310 nm	SM
508322	Fast Ethernet	20 km	Industrial Grade	100Base-TX to 100Base-FX (SC)	1310 nm	SM
508216	1G	120 km	With PoE+ Injector	1000Base-T to SFP Port	-	-
506533	1G	550 m		1000Base-T to 1000Base-SX (SC)	850 nm	MM
508315	1G	550 m	Autonegotiation	10/100/1000Base-T to 1000Base-SX (ST)	850 nm	MM
508544	1G	550 m	Autonegotiation	10/100/1000Base-T To 1000Base-SX (SC)	850 nm	MM
545075	1G	20 km	WDM BiDi, use with #545068	10/100/1000Base-TX to 1000Base-LX (SC)	1310/1550 nm	SM
545068	1G	20 km	WDM BiDi, use with #545075	10/100/1000Base-TX to 1000Base-LX (SC)	1550/1310 nm	SM
507349	1G	20 km		10/100/1000Base-T to 1000Base-LX (SC)	1310 nm	SM
508346	1G	20 km	Industrial Grade	10/100/1000Base-TX to 1000Base-LX (SC)	1310 nm	SM
508209	1G	20 km	With PoE+ Injector	1000Base-T to 1000Base-LX (SC)	1310 nm	SM
508193	10G	-		10GBase-T to SFP+ Port	-	-
510493	1G	-	Blank SFP slot	10/100/1000Base-TX to SFP slot, empty	-	-
507356	-	-	14-Slot Media Converter Chassis	-	-	-



**Fast Ethernet Media Converter**

- [506502] 10/100Base-TX to 100Base-FX (SC) Multi-Mode, 2 km
- [506519] 10/100Base-TX to 100Base-FX (ST) Multi-Mode, 2 km
- [507332] 10/100Base-TX to 100Base-FX (SC) Single-Mode, 20 km

**Fast Ethernet WDM Bi-Directional Media Converter**

- [510530] 10/100Base-TX to 100Base-FX (SC) Single-Mode, 20 km, WDM (RX1310/TX1550)
- [510547] 10/100Base-TX to 100Base-FX (SC) Single-Mode, 20 km, WDM (RX1550/TX1310)



**Industrial Media Converter**

- [508322] Fast Ethernet, 100Base-TX to 100Base-FX (SC) Single-Mode, 20 km, IP40-rated
- [508346] Gigabit, 10/100/1000Base-TX to 1000Base-LX (SC), Single-Mode 20 km, IP40-rated



**Gigabit Ethernet Media Converter**

- [508315] 10/100/1000Base-T to 1000Base-SX (ST) Multi-Mode, 550 m, Autonegotiation
- [508544] 10/100/1000Base-T to 1000Base-SX (SC) Multi-Mode, 550 m, Autonegotiation



**Gigabit Ethernet WDM Bi-Directional Media Converter**

- [545075] 10/100/1000Base-TX to 1000Base-LX (SC), SM, 20 km, WDM (RX1310/TX1550)
- [545068] 10/100/1000Base-TX to 1000Base-LX (SC), SM, 20 km, WDM (RX1550/TX1310)



**Gigabit Ethernet Media Converter**

- [506533] 1000Base-T to 1000Base-SX (SC) Multi-Mode, 550 m
- [507349] 10/100/1000Base-T to 1000Base-LX (SC) Single-Mode, 20 km

**Gigabit PoE+ Media Converter and PoE+ Injector**

- [508216] 1000Base-T RJ45 Port to SFP Port, 120 km
- [508209] 1000Base-T RJ45 Port to 1000Base-LX (SC) Single-Mode, 20 km



**10G Ethernet Media Converter**

- [508193] 10GBase-T RJ45 to 10GBase-R

**Gigabit Ethernet to SFP Media Converter**

- [510493] 10/100/1000Base-TX to SFP slot, empty

**14-Slot Media Converter Chassis**

- [507356] Includes redundant power supply, 19" rackmountable, 2U



**USB-C to 5GBASE-T Ethernet Adapter**

[153461] SuperSpeed USB 3.2 Gen 1 with 5 Gbps USB & Multi-Gigabit Ethernet Connection Speeds



**USB-C to 2.5GBASE-T Ethernet Adapter**

[153300] SuperSpeed USB 3.2 Gen 1; 10/100/1000 Mbps & 2.5 Gbps, Multi-Gigabit Ethernet



**USB-C to Gigabit Network Adapter with Power Delivery Port**

[153454] Gigabit (10/100/1000 Mbps) Ethernet port, Power Delivery up to 60 W (20 V / 3 A)



**USB-C to Gigabit Network Adapter**

[507585] Gigabit (10/100/1000 Mbps) Ethernet port, USB 3.2 Gen 1



**USB-C to 3-Port USB-A Hub with Gigabit Network Adapter**

[507608] Three USB 3.2 Gen 1 (5 Gbps) ports; 10/100/1000 Mbps Gigabit Ethernet



**USB-A to 3-Port USB-A Hub with Gigabit Ethernet Adapter**

[507578] Three USB 3.2 Gen 1 (5 Gbps) ports; 10/100/1000 Mbps Gigabit Ethernet



**USB-A to Gigabit Network Adapter**

[506847] 10/100/1000 Mbps Gigabit Ethernet, USB 3.0



**USB-A to Fast Ethernet Adapter**

[506731] 10/100 Mbps Fast Ethernet, USB 2.0

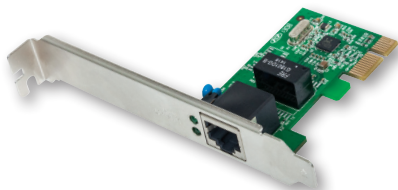

**Gigabit Network Card**

[522533] Gigabit PCI Express Network Card



**10 Gigabit PCI Express Network Card**

[507950] 1-Port PCI Express 2.0, 10GBASE-T, 5GBASE-T, 2.5GBASE-T

**NEW**



**USB-A to SFP Fiber Optic Converter**

[152297] USB 3.2 Gen 1, 1000 Mbps Ethernet Optical Network Connection, Open SFP Slot

**NEW**



**USB-C to SFP Fiber Optic Converter**

[153508] USB 3.2 Gen 1, 1000 Mbps Ethernet Optical Network Connection, Open SFP Slot

**NEW**



**1080p HDMI KVM over IP Extender Kit**

[207683] Extends a 1080p@60Hz HDMI Signal up to 120 m over a Cat6 Cable or an IP-enabled Network, USB-A Ports for PC/Mouse/Keyboard on Transmitter and Receiver

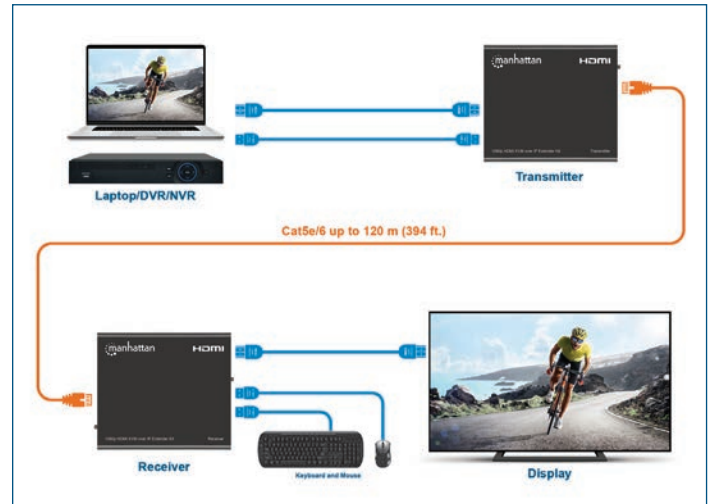

**High-Speed HDMI Active Optical Cable**

Extends an HDMI signal over long distances without an external repeater, signal loss or interference; fiber and copper-wire hybrid for a thinner cable



**Detachable connector for a narrower connection through walls**

Image	Barcode	Resolution /Hertz	Connection	Length	Description	Ethernet Channel	Packaging
	353243	4K@60Hz	Male/Male	20 m	CMP/CPR (plenum) rated High Speed HDMI Active Optical Cable (AOC), fiber and copper-wire hybrid for extra long distances without interference.	Yes	Brown Box
	355193	4K@60Hz	Male/Male	30 m		Yes	Brown Box
	355698	4K@60Hz	Male/Male	50 m		Yes	Brown Box
	355490	4K@60Hz	Male/Male	70 m		Yes	Brown Box
	355506	4K@60Hz	Male/Male	100 m		Yes	Brown Box
	355513	4K@60Hz	Male/Male	20 m	High Speed HDMI Active Optical Cable (AOC), fiber and copper-wire hybrid for extra long distances without interference.	Yes	Brown Box
	355520	4K@60Hz	Male/Male	30 m		Yes	Brown Box
	355537	4K@60Hz	Male/Male	50 m		Yes	Brown Box
	355544	4K@60Hz	Male/Male	70 m		Yes	Brown Box
	355551	4K@60Hz	Male/Male	100 m		Yes	Brown Box





BUY AS  
KIT #208253

USE TOGETHER



**H.264 HDMI Over IP Extender Transmitter**

[207577] Distributes H.264-compressed 1080p Signal up to 120 m (396 ft.) Over a Network, Unicast & Multicast Streaming, HDMI Loop-out on Transmitter, IR Support, Mountable

**H.264 HDMI Over IP Extender Receiver**

[208246] Supports an H.264-compressed 1080p Signal up to 120 m (396 ft.) Over a Network, Unicast & Multicast Streaming, IR Support, Mountable



USE TOGETHER



**H.264 HDMI Over IP Video Wall Extender - Transmitter**

[208338] Distributes an H.264-compressed 1080p HDMI Signal up to 500 m (1,640 ft.) Over a Network; Video Wall, Unicast & Multicast Streaming; Mountable

**H.264 HDMI Over IP Video Wall Extender - Receiver**

[208345] Distributes an H.264-compressed 1080p HDMI Signal up to 500 m (1,640 ft.) Over a Network; Video Wall, Unicast & Multicast Streaming; Mountable



BUY AS  
KIT #208284

USE TOGETHER



**HDMI over IP Extender Transmitter**

[208260] Distributes a 1080p Signal up to 120 m (396 ft.) Over a Network, Unicast & Multicast Streaming, IR Support, Mountable

**HDMI over IP Extender Receiver**

[208277] Supports a 1080p Signal up to 120 m (396 ft.) Over a Network, Unicast & Multicast Streaming, IR Support, Mountable

**NEW**



**4K HDMI over Ethernet Extender Kit**

[207645] Extends Distances of 4K@30Hz up to 50 m (165 ft.) with a Single Ethernet Cable, Transmitter (TX) and Receiver (RX), IR Support, Black



**4K HDMI Repeater / Extender**

[207621] Active, Distances up to 40 m (131 ft.), Simple One-Piece Solution, Black

**NEW**



**1080p Compact HDMI over Ethernet Extender Kit**

[207539] Extends an HDMI Signal up to 60 m (196 ft.) at 1080p@60Hz with a Single Cat6 Ethernet Cable, Transmitter and Receiver, Power over Cable, Ultra Slim Design, Black



Contains 1 Transmitter & 1 Receiver

**1080p HDMI over IP Extender Splitter Kit**

[207959] Extends 1080p Signal up to 120 m (396 ft.) with a Network Switch and Single Ethernet Cable, IR Support



**1080p HDMI over Ethernet Extender Kit**

[207461] Up to 50 m (164 ft.) with Single Cat6 Cable, Tx & Rx Modules, IR Support



**1080p HDMI over Ethernet Extender with Integrated Cables**

[207386] Distances up to 30 m (100 ft.) with Two Ethernet Cables, Black



**VGA Cat5/5e/6 Extender**

[177344] Extends video and audio signals up to 300 m (984 ft.)



**USB Line Extender**

[179300] Extends the Distance to Any USB Device Up to 60 m (196 ft.)



**4K 4-Port HDMI Splitter**

[207805] 4K@60Hz, AC Powered



**4K 2-Port HDMI Splitter**

[207591] 4K@60Hz, AC Powered



**4K Compact 4-Port HDMI Splitter**

[207706] 4K@30Hz, AC Powered



**4K 2-Port HDMI Splitter**

[207669] 4K@30Hz, AC Powered



**1080p 2-Port HDMI Splitter**

[207652] 1080p@60Hz, USB Powered



**Professional Video Splitter**

[207331] 2-Port, VGA, SVGA, MultiSync



**DisplayPort to Dual HDMI - MST Hub**

[152716] DisplayPort Male to Two HDMI Females; Mirror, Extended and Video-Wall Modes Supported; 4K@30Hz; USB Powered



**DisplayPort to Dual DisplayPort - MST Hub**

[207768] DisplayPort Male to Two DisplayPort Females; Mirror, Extended and Video-Wall Modes Supported; 4K@30Hz; USB Powered

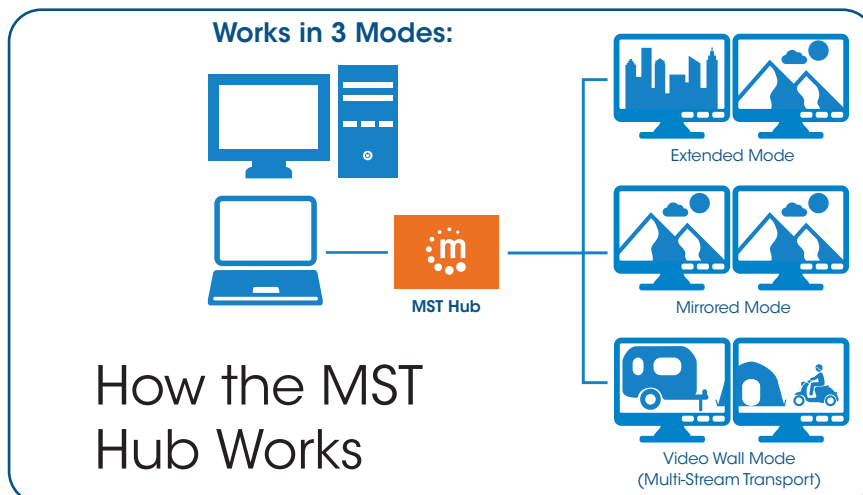





**4K Compact 3-Port HDMI Switch**

[207676] 4K@60Hz, AC Powered, Remote Control, Black



**4K 3-Port HDMI Switch**

[207522] 4K@30Hz, USB Powered, Remote Control, Black



**4K Bi-Directional 2-Port HDMI Switch**

[207850] 4K@60Hz, Manual Selection, Passive (No Power Required)



**1080p 2-Port HDMI Switch**

[207911] Automatic and Manual Switching, Black



**1080p 4-Port HDMI Multiviewer Switch**

[207881] Switch with Four Inputs on One Display, Video Bandwidth Amplifier, IR Remote Control, Black





**USB-C 11-in-1 Triple-Monitor Docking Station with MST, 4K@30Hz**

[153478]



Takes up no extra space on your desk. Ideal for laptops with USB port on the left.

**Compact Travel Dock With PD Charger, 1080p@60Hz**

[130554]

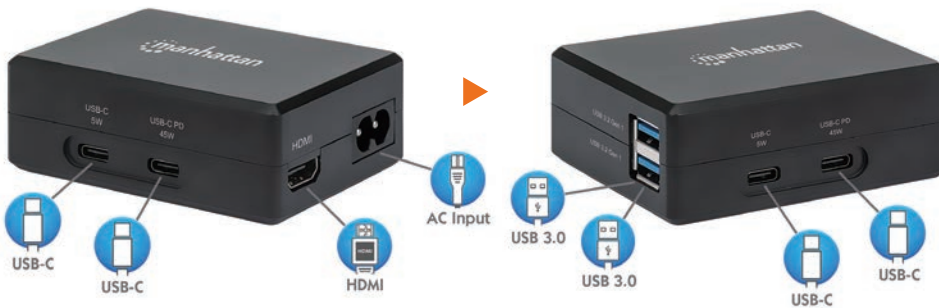

A dock for your phone or notebook; does not need an external power supply  
---  
Very compact with only 80x63x30 mm

**USB-C 11-in-1 Docking Station, 4K@30Hz**

[152808]



**USB-C 8-in-1 Dock with Wireless Charging Pad, 4K@30Hz**

[166560]



**USB-C Multiport Adapter, 4K@30Hz**

[152440]

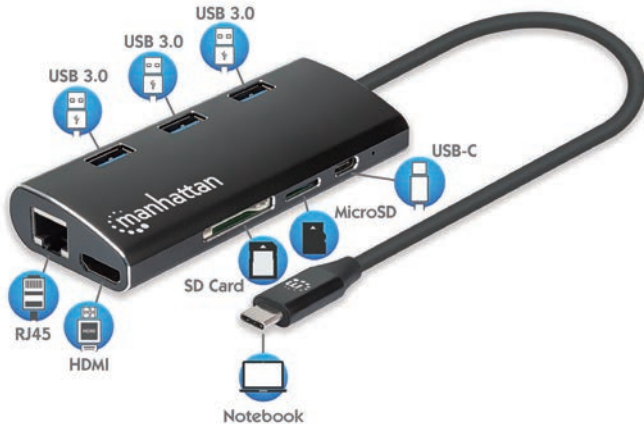

**USB-C to Dual HDMI Multiport Adapter, 4K@30Hz**

[152747]

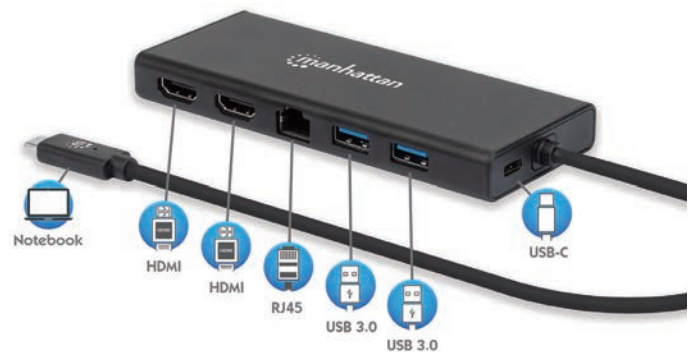

**USB-C Multiport Adapter, 4K@30Hz**

[152075]

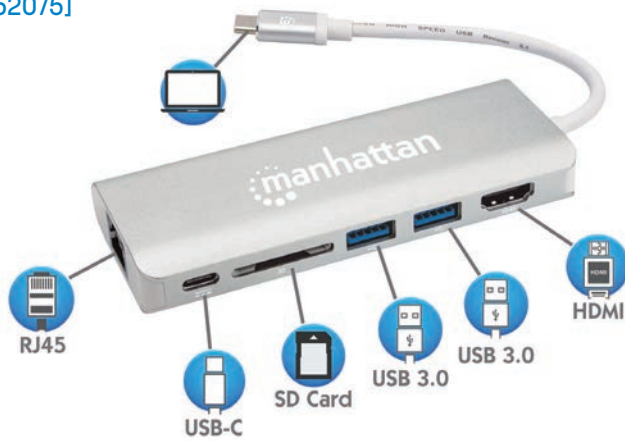

**USB-A Dual Monitor Multiport Adapter, 2K@60Hz**

[152846]



**USB-C Multiport Adapter, 4K@30Hz**

[152372]





**USB-C 3-in-1 Multiport A/V Converter**

[152983] USB-C Male to DVI, HDMI or VGA Females; 4K@30Hz on HDMI Port, 1080p on VGA or DVI Ports



**USB-C HDMI Docking Converter**

[152037] USB-C Male to HDMI, USB-A and USB-C Females, Multiport Converter



**USB-C 4-in-1 Audio/Video Converter**

[152600] USB-C Male to HDMI/DP/VGA/DVI Female



**USB-C to HDMI Converter**

[151788] USB-C Male to HDMI Female



**USB-C to DisplayPort Converter**

[152020] USB-C Male to DisplayPort Female



**USB-C to VGA Converter**

[151771] USB-C Male to VGA Female



**USB-C to DVI Converter**

[152051] USB-C Male to DVI Female





**USB-C to HDMI Converter with Power Delivery Port**

[153416] 4K@60Hz Resolution, Power Delivery up to 60 W (20 V / 3 A)



**USB-C to DisplayPort Converter with Power Delivery Port**

[153447] 4K@60Hz Resolution, Power Delivery up to 60 W (20 V / 3 A)



**USB-C to VGA Converter with Power Delivery Port**

[153430] Supports up to 1080p Resolution, Power Delivery (PD) up to 60 W (20 V / 3 A)



**USB-C to DVI Converter with Power Delivery Port**

[153423] Supports up to 1920x1200@60Hz Resolution, Power Delivery (PD) up to 60 W (20 V / 3 A)



**Mini DisplayPort to DisplayPort Adapter**

[354141] Mini DisplayPort Male to DisplayPort Female, Adapter



**Active Mini DisplayPort to HDMI Adapter**

[152570] Mini DisplayPort Male to HDMI Female, 4K@60Hz



**Passive Mini DisplayPort to HDMI Adapter**

[151399] White, Retail Box  
[151528] Black, Bag  
[322461] White, Bag  
Mini DisplayPort Male to HDMI Female, 1080p



**Active Mini DisplayPort to DVI-I Adapter**

[152549] Mini DisplayPort Male to DVI-I Dual-Link Female





**Passive Mini DisplayPort to DVI-I Adapter**

[322485] Mini DisplayPort Male to DVI-I Dual-Link Female



**Active Mini DisplayPort to VGA Adapter**

[151504] Mini DisplayPort Male to VGA Female, 1080p



**Mini DisplayPort to VGA Adapter**

[322508] Mini DisplayPort Male to VGA Female, Active



**Passive 2-in-1 4K DisplayPort Adapter**

[152587] DisplayPort Male to HDMI/VGA Female



**Passive DisplayPort to HDMI Adapter**

[151634] DisplayPort Male to HDMI Female, Cable Adapter, 1080p



**Passive DisplayPort to HDMI Adapter**

[151993] DisplayPort Male to HDMI Female, Dongle Adapter, 1080p



**DisplayPort 1.2a to DVI-D Adapter**

[152228] DisplayPort 1.2a Male to DVI-D Female, Active, 23 cm (9 in.), Black



**VGA and USB to HDMI Converter**

[152426] Converts Analog VGA Video and USB Audio to a Digital HDMI Signal



**DisplayPort to VGA Converter Cable**

[151962] DisplayPort Male to VGA HD15 Female Adapter, 15 cm (6 in.), Active



**HDMI to VGA Converter**

[151467] Bag

[151436] Blister

HDMI Male to VGA Female, Optional USB Micro-B Power Port



**HDMI to VGA Converter**

[151559] Bag

[151450] Blister

HDMI Male to VGA Female, with Audio, Optional USB Micro-B Power Port



**HDMI to VGA Micro Converter**

[151542] HDMI Male to VGA Female with Audio, Optional USB Micro-B Power Port



**USB-C to 3.5 mm Audio Adapter with Dongle**

[153317] USB-C Male to 3.5 mm Mic-in and Audio-Out Females



**USB-A to 3.5 mm Audio Adapter with Dongle**

[153324] USB-A Male to 3.5 mm Mic-in and Audio-Out Females



**USB-C to Headphone Jack Adapter**

[153355] USB-C Male to 3.5 mm Audio and USB-C Power Delivery Females



**USB-C Audio Adapter**

[153348] USB-C Male to USB-C Audio and USB-C Power Delivery Females



**USB-A to 3.5 mm Audio Adapter**

[150859] USB-A Male to 3.5 mm Mic-in and Audio-Out Females



**USB-A to 3.5 mm Audio Adapter with Volume Controls**

[152341] USB-A Male to 3.5 mm Mic-in and Audio-Out Females

## Network Switches



### Fast Ethernet Switch

[560672] 5-Port  
[560689] 8-Port  
Compact Size, Plastic, Power Supply Included



### Gigabit Ethernet Switch

[560696] 5-Port  
[560702] 8-Port  
Compact Size, Plastic, Power Supply Included

## KVM Switches



### Compact KVM Switch

[151252] 2-Port  
[151269] 4-Port  
Connects 2/4 computers with VGA Output to 1 Mouse, Keyboard and Monitor, Included 3-in-1 Connection Cable with 3.5mm Audio, VGA and USB to VGA, 1.8 m



### 2-Port Mini KVM Switch

[151245] Connects 2 Computers with VGA Output to 1 Mouse, Keyboard and Monitor, Built-in 3-in-1 Connection Cable with 3.5mm Audio, VGA and USB to VGA, 1.8 m

## HDMI Switches



### 4K 3-Port HDMI Switch

[207874] 4K@60Hz, USB Powered, Built-in 0.5 m Cable



### 1080p HDMI Switch

[207416] 2-Port  
[207843] 3-Port  
Self-Powered, Two/Three Sources to One Display, Built-in 0.5 m Cable

## Sharing Switch



### Hi-Speed USB 2.0 Sharing Switch

[162005] Share a USB Printer, Hard Drive or Other Device Between Two Computers





**3-Port USB 3.2 Gen 1 Hub with Gigabit Network Adapter**

[507608] USB-C Plug  
 [507578] USB-A Plug  
 Three USB 3.2 Gen 1 (5 Gbps) ports;  
 10/100/1000 Mbps Gigabit Ethernet



**3-Port USB-C 3.2 Gen 1 Hub with Power Delivery**

[163552] USB Type-C Male to Three Type-A Ports Female and One Type-C Power-Delivery Port Female



**3-Port USB 3.2 Gen 1 Hub with Card Reader**

[164948] USB-C Plug  
 [164931] USB-A Plug  
 USB-A or USB-C Male to Three USB-A Females and SD/  
 MicroSD Card Reader, 5 Gbps Transfer Speeds,  
 Bus Powered



**4-Port USB 3.2 Gen 1 Hub**

[162746] Type-C Plug, Four Type-A Ports, Bus Powered



**7-Port Industrial USB 3.2 Gen 1 Hub**

[164405] Seven USB Type-A Ports, 20 kV ESD Protection,  
 A/C, Bus and Terminal-Block Power Options, DIN Rail, Wall  
 Mountable, Metal Housing, Screw-Lock Security



**4-Port USB 3.2 Gen 1 Hub**

[164924] USB-C Plug  
 [164900] USB-A Plug  
 USB-C or USB-A Male to Four USB-A Females, 5 Gbps  
 Transfer Speeds, Bus Powered



**3-Port USB 3.2 Gen 1 Hub and Card Reader**

[163590] Type-A Plug, Supports MicroSD, SD and MMC  
 Memory Cards, Bus Powered



**4-Port USB 3.2 Gen 1 Type-A Hub**

[163767] Type-A Plug, Aluminum Housing, Bus Powered





**4-Port USB 3.2 Gen 1 Type-A Hub**

[162296] Bus Power  
[162302] AC/Bus Power



**28-Port MondoHub II**

[163606] Adds 28 USB Ports to Any Computer - 24 USB 2.0 & Four USB 3.0 Ports, AC Power



**4-Port USB 2.0 Hub**

[164818] Four Hi-Speed USB-A Ports, 60 cm Built-in USB-A Cable, Bus Powered, Black



**10-Port USB 2.0 Desktop Hub**

[161572] 10 USB 2.0 Type-A Ports, Bus or AC Power



**4-Port USB 2.0 Micro Hub**

[160605] 4 Ports, Bus Power



**USB 3.0/2.0 Combo Hub**

[163828] One SuperSpeed USB 3.0 port, Three Hi-Speed USB 2.0 ports, Bus Powered

## The M.2 Interface – what is it and what are its benefits?

M.2 is a specification for internal expansion cards on PC mainboards and laptops. M.2 was designed as a successor of the mSATA interface and initially introduced by Intel in 2012 under the label Next Generation Form Factor (NGFF). As for usage and interface variety, M.2 is more flexible because it can not only transmit SATA signals but also USB and PCIe.



### M.2 NVMe SSD Enclosure

**[130530]** USB 3.2 gen 2, USB-C Female Connection, UASP-compliant, Aluminum

- Offers USB 3.2 Gen 2 connection to support data transfer speeds up to 10 Gbps
- Supports SATA M.2 NVMe SSDs: 42 mm, 60 mm and 80 mm
- Supports only M-Key PCIe NVMe M.2 SSDs up to 2 TB
- Compatible with SATA revisions I (1.5 Gbps), II (3 Gbps) and III (6 Gbps)



### Hi-Speed USB to SATA/IDE Adapter

**[179195]** 3-in-1 with One-Touch Backup

- Provides fast data access to IDE and SATA drives with one-touch backup
- Supports data transfer SATA speeds up to 1.5 Gbps and Hi-Speed USB speeds up to 480 Mbps
- Supports 48-bit LBA (Logical Block Addressing)
- Fits external SATA and IDE hard drives up to 5.25"
- Plug and play; Windows, Mac and Linux compatible and hot-swappable

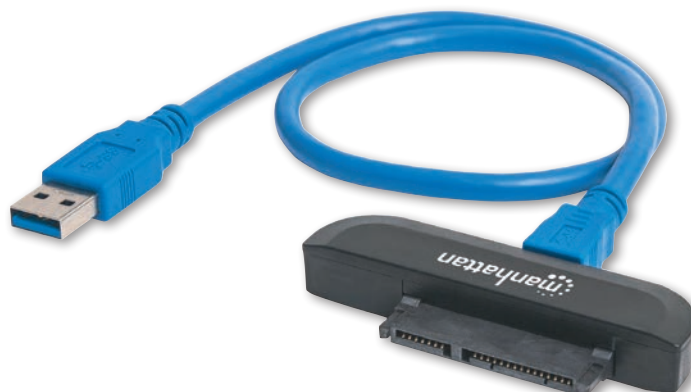

### SuperSpeed USB 3.0 to SATA Adapter

**[130424]** USB 3.0 to SATA 2.5" Adapter

- Provides fast data access to SATA drives
- Supports data transfer between SATA and SuperSpeed USB, up to 5 Gbps
- Supports 48-bit LBA (Logical Block Addressing)
- Fits external SATA hard drives up to 2.5"
- Plug and play; Windows, Mac and Linux compatible and hot-swappable



# HDMI™

HIGH-DEFINITION MULTIMEDIA INTERFACE

# TECH OVERVIEW

	HDMI™ STANDARD	HDMI™ HIGH SPEED	HDMI™ HIGH SPEED with ETHERNET	HDMI™ PREMIUM Certified Cable	HDMI™ ULTRA HIGH SPEED
sRGB	✓	✓	✓	✓	✓
Consumer Electronics Control (CEC)	✓	✓	✓	✓	✓
DVD Audio support	✓	✓	✓	✓	✓
Super Audio CD (DSD) support	✓	✓	✓	✓	✓
Deep color		✓	✓	✓	✓
Auto Audio to video synchronization lipsync			✓	✓	✓
Dolby True HD			✓	✓	✓
bitstream capable			✓	✓	✓
Updated list of CEC commands			✓	✓	✓
3D over HDMI			✓	✓	✓
Ethernet channel			✓	✓	✓
Audio return channel (ARC)			✓	✓	✓
4K resolution support			✓	✓	✓
4K 50/60 support (3840x2160p 60 Hz)				✓	✓
4K 3D support				✓	✓
32 Kanal Audio support				✓	✓
1536 kHz audio support				✓	✓
1080p 3D HFR support				✓	✓
21:9 Cinemascope support				✓	✓
Multi-Stream Audio & Video support				✓	✓
18 Gbit/s				✓	✓
High Dynamic Range				✓	✓
Color Space					✓
ITU-R BT. 2020					✓
Dyn. synch. of Multi-Stream Audio & Video					✓
Dynamic HDR (HDR dynamic metadata)					✓
Enhanced audio return channel (eARC)					✓
Variable Refresh Rate (VRR)					✓
Quick Media Switching (QMS)					✓
Quick Frame Transport (QFT)					✓
Auto Low Latency Mode (ALLM)					✓
Display Stream Compression (DSC)					✓
48 Gbit/s					✓
4K resolution support (120 Hz)					✓
8K resolution support (60 Hz)					✓
8K 3D support					✓



Image	Barcode	Resolution /Hertz	Connection	Length	Description	Ethernet Channel	Packaging
	355933	8K@60Hz	Male/Male	1 m		Yes	Bag
	355940	8K@60Hz	Male/Male	2 m		Yes	Bag
	355957	8K@60Hz	Male/Male	3 m		Yes	Bag
	353243	4K@60Hz	Male/Male	20 m	CMP/CPR (plenum) rated High Speed HDMI Active Optical Cable (AOC), fiber and copper-wire hybrid for extra long distances without interference.	Yes	Brown Box
	355193	4K@60Hz	Male/Male	30 m		Yes	Brown Box
	355698	4K@60Hz	Male/Male	50 m		Yes	Brown Box
	355490	4K@60Hz	Male/Male	70 m		Yes	Brown Box
	355506	4K@60Hz	Male/Male	100 m		Yes	Brown Box
	355513	4K@60Hz	Male/Male	20 m	High Speed HDMI Active Optical Cable (AOC), fiber and copper-wire hybrid for extra long distances without interference.	Yes	Brown Box
	355520	4K@60Hz	Male/Male	30 m		Yes	Brown Box
	355537	4K@60Hz	Male/Male	50 m		Yes	Brown Box
	355544	4K@60Hz	Male/Male	70 m		Yes	Brown Box
	355551	4K@60Hz	Male/Male	100 m		Yes	Brown Box
	354837	4K@60Hz	Male/Male	1 m		Yes	Bag
	355346	4K@60Hz	Male/Male	1.8 m		Yes	Bag
	355353	4K@60Hz	Male/Male	3 m		Yes	Bag
	355360	4K@60Hz	Male/Male	5 m		Yes	Bag
	355377	4K@60Hz	Male/Male	9 m		Yes	Bag
	355599	4K@60Hz	Male/Male	0.5 m	Flat	Yes	Bag
	355605	4K@60Hz	Male/Male	1 m		Yes	Bag
	355612	4K@60Hz	Male/Male	2 m		Yes	Bag
	355629	4K@60Hz	Male/Male	3 m		Yes	Bag
	355636	4K@60Hz	Male/Male	5 m		Yes	Bag
	355643	4K@60Hz	Male/Male	10 m		Yes	Bag
	355650	4K@60Hz	Male/Male	15 m		Yes	Bag
	353946	4K@60Hz	Male/Male	3 m	In-wall CL3-rated	Yes	Bag
	353960	4K@60Hz	Male/Male	8 m		Yes	Bag
	353977	4K@60Hz	Male/Male	10 m		Yes	Bag
	394406	4K@60Hz	Male/Male	0.5 m	Ultra-thin	Yes	Bag
	394352	4K@60Hz	Male/Male	1 m		Yes	Bag
	394369	4K@60Hz	Male/Male	2 m		Yes	Bag
	394376	4K@60Hz	Male/Male	3 m		Yes	Bag
	153591	4K@60Hz	Male/Male	1 m	USB-C to HDMI Adapter Cable	No	Bag
	153607	4K@60Hz	Male/Male	2 m		No	Bag
	354523	4K@60Hz	Male/Female	20 cm	High Speed HDMI Extension Cable, Space-saving port extension, ideal for wall-mounted TVs	Yes	Bag
	353465	4K@60Hz	Female/Female	-	HDMI Coupler, connects two cables to overcome distance limitations	-	Bag
	353519	4K@60Hz	Female/Male	-	HDMI Adapter, 90° upward angle allows for easy connection in the most inconvenient places	-	Bag
	353502	4K@60Hz	Female/Male	-	HDMI Adapter, 90° downward angle allows for easy connection in the most inconvenient places	-	Bag





Image	Barcode	Resolution /Hertz	Connection	Length	Description	Ethernet Channel	Packaging
	152235	4K@30Hz	Male/Male	1 m	USB-C to HDMI Adapter Cable	-	Bag
	151764	4K@30Hz	Male/Male	2 m		-	Bag
	324427	4K@30Hz	Male/Micro Male	2 m	Micro HDMI 	-	Bag
	304955	4K@30Hz	Male/Mini Male	1.8 m	Mini HDMI 	-	Bag
	323192	4K@30Hz	Male/Male	1 m		Yes	Bag
	355728	4K@30Hz	Male/Male	1.8 m		Yes	Bag
	323215	4K@60Hz	Male/Male	2 m		Yes	Bag
	355735	4K@30Hz	Male/Male	2 m		Yes	Bag
	323222	4K@30Hz	Male/Male	3 m		Yes	Bag
	323239	4K@30Hz	Male/Male	5 m		Yes	Bag
	323260	4K@30Hz	Male/Male	15 m		Yes	Bag
	308816	4K@30Hz	Male/Male	1 m		-	Bag
	355308	4K@30Hz	Male/Male	1.5 m		-	Bag
	306119	4K@30Hz	Male/Male	1.8 m		-	Bag
	355711	4K@30Hz	Male/Male	2 m		-	Bag
	306126	4K@30Hz	Male/Male	3 m		-	Bag
	306133	4K@30Hz	Male/Male	5 m		-	Bag
	308434	4K@30Hz	Male/Male	15 m		-	Bag
	353274	1080p@60Hz	Male/Male	7.5 m		Yes	Bag
	308441	1080p@60Hz	Male/Male	7.5 m		-	Bag
	323246	1080p@60Hz	Male/Male	10 m		Yes	Bag
	322539	1080p@60Hz	Male/Male	10 m		-	Bag
	308458	1080p@60Hz	Male/Male	22.5 m		-	Bag

Image	Barcode	Resolution /Hertz	Connection	Length	Description	Color	Packaging
 <b>NEW</b>	353595	8K@60Hz	DP Male/DP Male	1 m	DisplayPort 1.4, Braided	Black	Bag
	353618	8K@60Hz	DP Male/DP Male	2 m		Black	Bag
	353625	8K@60Hz	DP Male/DP Male	3 m		Black	Bag
 <b>NEW</b>	355568	8K@60Hz	DP Male/DP Male	1 m	DisplayPort 1.4	Black	Bag
	355575	8K@60Hz	DP Male/DP Male	2 m		Black	Bag
	355582	8K@60Hz	DP Male/DP Male	3 m		Black	Bag
	306935	4K@60Hz	DP Male/DP Male	1 m	DisplayPort 1.2	Black	Bag
	307116	4K@60Hz	DP Male/DP Male	2 m		Black	Bag
	307093	4K@60Hz	DP Male/DP Male	3 m		Black	Bag
	354110	4K@60Hz	DP Male/DP Male	5 m		Black	Bag
	354127	4K@60Hz	DP Male/DP Male	7.5 m		Black	Bag
	354134	4K@60Hz	DP Male/DP Male	10 m		Black	Bag
 <b>NEW</b>	354844	8K@60Hz	USB-C Male/DP Male	1 m	USB-C to DisplayPort 1.4 Adapter Cable	Black	Bag
	354851	8K@60Hz	USB-C Male/DP Male	2 m		Black	Bag
	152471	4K@60Hz	USB-C Male/DP Male	1 m	USB-C to DisplayPort 1.2 Adapter Cable	Black	Bag
	152464	4K@60Hz	USB-C Male/DP Male	2 m		Black	Bag
	153195	4K@60Hz	DP Male/HDMI Male	1 m	DisplayPort 1.2 to HDMI Adapter Cable	Black	Bag
	153201	4K@60Hz	DP Male/HDMI Male	1.8 m		Black	Bag
	153218	4K@60Hz	DP Male/HDMI Male	3 m		Black	Bag
	152662	1080p@60Hz	DP Male/HDMI Male	1 m	DisplayPort 1.1 to HDMI Adapter Cable	Black	Bag
	152679	1080p@60Hz	DP Male/HDMI Male	1.8 m		Black	Bag
	153188	1080p@60Hz	DP Male/HDMI Male	3 m		Black	Bag
	152136	1080p@60Hz	DP Male/DVI-D 24+1 Male	3 m	DisplayPort 1.2a to DVI Adapter Cable	Black	Bag
	324748	4K@60Hz	Mini DP Male/DP Male	2 m	Mini DisplayPort 1.2 to DisplayPort 1.2 Adapter Cable	White	Bag
	153287	4K@60Hz	Mini DP Male/HDMI Male	1.8 m	Mini DisplayPort 1.2 to HDMI Adapter Cable	Black	Bag
	153232	1080p@60Hz	Mini DP Male/HDMI Male	1.8 m	Mini DisplayPort 1.1 to HDMI Adapter Cable	Black	Bag
	152150	1080p@60Hz	Mini DP Male/DVI-D 24+1 Male	1.8 m	Mini DisplayPort 1.2a to DVI Cable	Black	Bag

## DVI Cables

Image	Barcode	Resolution	Connection	Length	Description	Color	Packaging
	328838	1080p@60Hz	DVI-D 24+1 Male/ DVI-D 24+1 Male	1 m	DVI-D Dual Link Cable	Black	Bag
	322782	1080p@60Hz	HDMI Male/ DVI-D 24+1 Male	1 m	HDMI to DVI-D Dual Link Adapter Cable	Black	Bag
	372503	1080p@60Hz	HDMI Male/ DVI-D 24+1 Male	1.8 m		Black	Bag
	372510	1080p@60Hz	HDMI Male/ DVI-D 24+1 Male	3 m		Black	Bag
	152457	1080p@60Hz	USB-C Male/ DVI-D 18+1 Male	2 m	USB-C to DVI Adapter Cable	Black	Bag

## VGA Cables

Image	Barcode	Resolution	Connection	Length	Description	Color	Packaging
	311731	1080p@60Hz	HD15 Male/HD15 Male	1.8 m	SVGA Monitor Cable	Black	Bag
	311748	1080p@60Hz	HD15 Male/HD15 Male	3 m		Black	Bag
	312776	1080p@60Hz	HD15 Male/HD15 Male	10 m		Black	Bag
	317757	1080p@60Hz	HD15 Male/HD15 Male	1.8 m	SVGA Monitor Cable with Ferrite Cores	Black	Bag
	317733	1080p@60Hz	HD15 Male/HD15 Male	3 m		Black	Bag
	317696	1080p@60Hz	HD15 Male/HD15 Male	10 m		Black	Bag
	372183	1080p@60Hz	HD15 Male/HD15 Male	15 m		Black	Bag
	372190	1080p@60Hz	HD15 Male/HD15 Male	20 m		Black	Bag
	373715	1080p@60Hz	HD15 Male/HD15 Male	30 m		Black	Bag

## Audio Cables



Image	Barcode	Connection	Length	Description	Color	Packaging
 <b>NEW</b>	355988	3.5 mm Male/Male	1 m	Stereo Audio Aux Cable, Slim Design, Gold-plated Contacts, TRRS/4-pole	Black/Silver	Bag
	355995	3.5 mm Male/Male	2 m		Black/Silver	Bag
	356008	3.5 mm Male/Male	3 m		Black/Silver	Bag
	356015	3.5 mm Male/Male	5 m		Black/Silver	Bag
 <b>NEW</b>	356022	3.5 mm Male/Female	1 m	Stereo Audio Aux Extension Cable, Slim Design, Gold-plated Contacts, TRRS/4-pole	Black/Silver	Bag
	356039	3.5 mm Male/Female	2 m		Black/Silver	Bag
	356046	3.5 mm Male/Female	3 m		Black/Silver	Bag
	356053	3.5 mm Male/Female	5 m		Black/Silver	Bag
 <b>NEW</b>	356060	Toslink S/PDIF Male/Male	1 m	Toslink Digital Optical Audio Cable, Gold-plated Contacts, Immunity to EMI and RFI	Black	Bag
	356077	Toslink S/PDIF Male/Male	2 m		Black	Bag
	356084	Toslink S/PDIF Male/Male	3 m		Black	Bag
	356091	Toslink S/PDIF Male/Male	5 m		Black	Bag

Image	Barcode	Transfer Speed	Connection	Length	Description	Color	Packaging
	355223	10 Gbps	C Male/C Male	1 m	USB 3.2 Gen 2 Cable, 100 W, 5 A, <b>recommended for laptop and docking station connectivity</b>	Black	Bag
	354899	10 Gbps	C Male/C Male	0.5 m	USB 3.2 Gen 2 Cable, 60 W, 3 A, <b>ideal for PD chargers</b>	Black	Bag
	353526	10 Gbps	C Male/C Male	1 m		Black	Bag
	355964	10 Gbps	C Male/C Male	3 m		Black	Bag
	355971	10 Gbps	C Male/C Male	5 m		Black	Bag
	355667	5 Gbps	C Male/C Male	0.5 m	USB 3.2 Gen 1 Cable, 60 W, 3 A	Black	Bag
	354905	5 Gbps	C Male/C Male	2 m		Black	Bag
	<b>NEW</b> 355674	5 Gbps	C Male/C Male	3 m		Black	Bag
	355247	480 Mbps	C Male/C Male	2 m	USB 2.0 Cable 100 W, 5 A	Black	Bag
	354868	480 Mbps	C Male/C Male	0.5 m	USB 2.0 Cable 60 W, 3 A	Black	Bag
	353342	480 Mbps	C Male/C Male	1 m		Black	Bag
	354875	480 Mbps	C Male/C Male	2 m		Black	Bag
	354882	480 Mbps	C Male/C Male	3 m		Black	Bag
	355230	10 Gbps	C Male/C Female	0.5 m	USB 3.2 Gen 2 Extension Cable, 100 W, 5 A <b>ideal as Extension Cable for Docking Stations</b>	Black	Bag
	355681	5 Gbps	C Male/C Female	1 m	USB 3.2 Gen 1 Cable, 60 W, 3 A	Black	Bag
	353540	5 Gbps	C Male/A Female	15 cm	USB 3.2 Gen 1 Cable	Blue	Bag
	354646	5 Gbps	C Male/A Female	-	USB 3.2 Gen 1 Type-C to Type-A Adapter	Black	Bag
	353311	480 Mbps	C Male/Micro-B Male	1 m	USB 2.0 Cable	Black	Bag
	353304	480 Mbps	C Male/B Male	1 m	USB 2.0 Cable	Black	Bag
	354950	480 Mbps	C Male/B Male	2 m		Black	Bag



Image	Barcode	Transfer Speed	Connection	Length	Description	Color	Packaging
	354677	480 Mbps	C Male/ Mini-B Female	-	USB 2.0 Type-C to Mini-B Adapter	Black	Bag
	354639	10 Gbps	A Male/C Male	0.5 m	USB 3.2 Gen 2 Cable	Black	Bag
	353373	10 Gbps	A Male/C Male	1 m		Black	Bag
	354974	5 Gbps	A Male/C Male	2 m	USB 3.2 Gen 1 Cable	Black	Bag
	354981	5 Gbps	A Male/C Male	3 m		Black	Bag
	354912	480 Mbps	A Male/C Male	0.5 m	USB 2.0 Cable	Black	Bag
	353298	480 Mbps	A Male/C Male	1 m		Black	Bag
	354929	480 Mbps	A Male/C Male	2 m		Black	Bag
	354936	480 Mbps	A Male/C Male	3 m		Black	Bag
	354714	10 Gbps	A Male/C Female	-	USB 3.2 Gen 2 Type-A to Type-C Adapter	Black	Bag
	354653	480 Mbps	A Male/C Female	-	USB 2.0 Type-A to Type-C Adapter	Black	Bag
	354295	5 Gbps	A Male/A Male	1.8 m	USB 3.2 Gen 1 Cable	Blue	Bag
	353885	480 Mbps	A Male/A Male	0.5 m	USB 2.0 Cable	Black	Bag
	353892	480 Mbps	A Male/A Male	1 m		Black	Bag
	306089	480 Mbps	A Male/A Male	1.8 m		Black	Bag
	353915	480 Mbps	A Male/A Male	3 m		Black	Bag
	325394	5 Gbps	A Male/A Female	1 m	USB 3.2 Gen 1 Extension Cable	Blue	Bag
	322379	5 Gbps	A Male/A Female	2 m		Blue	Bag
	322447	5 Gbps	A Male/A Female	3 m		Blue	Bag
	150712	5 Gbps	A Male/A Female	5 m	USB 3.2 Gen 1 Active Extension Cable, built-in repeater extends 5 m without signal loss	Black	Retail Box

Image	Barcode	Transfer Speed	Connection	Length	Description	Color	Packaging
	308519	480 Mbps	A Male/A Female	1 m	USB 2.0 Extension Cable	Black	Bag
	336314	480 Mbps	A Male/A Female	1.8 m		Translucent	Bag
	338653	480 Mbps	A Male/A Female	1.8 m		Black	Bag
	340496	480 Mbps	A Male/A Female	3 m		Translucent	Bag
	340502	480 Mbps	A Male/A Female	4.5 m		Translucent	Bag
	519779	480 Mbps	A Male/A Female	5 m	USB 2.0 Active Extension Cable, Daisy-Chainable	Translucent	Retail Box
	150248	480 Mbps	A Male/A Female	10 m		Black	Retail Box
	152365	480 Mbps	A Male/A Female	15 m		Black	Bag
	150958	480 Mbps	A Male/A Female	20 m		Black	Retail Box
	353335	480 Mbps	C Male/ Micro-B Female	15 cm	USB 2.0 Cable	Black	Bag
	374507	480 Mbps	A Male/B Male	0.5 m	USB 2.0 Cable	Black	Bag
	306218	480 Mbps	A Male/B Male	1 m		Black	Bag
	333405	480 Mbps	A Male/B Male	1.8 m		Translucent	Bag
	333368	480 Mbps	A Male/B Male	1.8 m		Black	Bag
	340458	480 Mbps	A Male/B Male	3 m		Translucent	Bag
	333382	480 Mbps	A Male/B Male	3 m		Black	Bag
	337779	480 Mbps	A Male/B Male	4.5 m		Black	Bag
	345408	480 Mbps	A Male/B Male	4.5 m		Translucent	Bag
	510424	480 Mbps	A Male/B Male	10 m	Active USB 2.0 Cable, built-in repeater for a single, nondaisy-chainable connection distance of 10 m	Translucent	Bag
	152389	480 Mbps	A Male/B Male	15 m	USB 2.0 Active Cable	Translucent	Bag
	333375	480 Mbps	A Male/Mini-B Male	1.8 m	USB 2.0 Cable	Black	Bag
	333412	480 Mbps	A Male/Mini-B Male	1.8 m		Translucent	Bag
	325677	480 Mbps	A Male/ Micro-B Male	0.5 m	USB 2.0 Cable	Black	Bag
	323987	480 Mbps	A Male/ Micro-B Male	1 m		White	Bag
	307178	480 Mbps	A Male/ Micro-B Male	1.8 m		Black	Bag
	324069	480 Mbps	A Male/ Micro-B Male	1.8 m		White	Bag
	325684	480 Mbps	A Male/ Micro-B Male	3 m		Black	Bag
	179027	480 Mbps	2 x PS/2/USB-A	-	USB to PS/2 Converter	Black	Bag

# Barcode Scanner Product Overview

Model #	Connection	Scan Light	Scan Range	Scan Width/ Scan Depth	Ambient Light in lux	1D/ 2D	Special Feature
460866	Wired USB	CCD	Contact	50 mm Scan Width	50,000	1D	
178488	Wired USB	CCD	Contact	60 mm Scan Width	5,000	1D	
401517	Wired USB	CCD	Contact	80 mm Scan Width	3,000	1D	
177665	Wired USB	Laser	Medium Range	300 mm Scan Depth	5,000	1D	
177429	Wired USB	Laser	Medium Range	300 mm Scan Depth	5,000	1D	IP42-rating
177672	Wired USB	CCD	Long Range	500 mm Scan Depth	10,000	1D	
460835	Wired USB	CCD	Long Range	500 mm Scan Depth	30,000	1D	
178433	Wired USB	CCD	Long Range	500 mm Scan Depth	100,000	1D	IP54-rating
179775	Wired USB	CCD	Medium Range	250 mm Scan Depth	100,000	1D & 2D	
177603	Wired USB	Laser	Medium Range	430 mm Scan Depth	100,000	1D & 2D	
178495	Wireless	CCD	Long Range	500 mm Scan Depth	100,000	1D	
178617	Wireless	CCD	Long Range	500 mm Scan Depth	100,000	1D	IP42-rating
179768	Wireless	CCD	Medium Range	250 mm Scan Depth	100,000	1D & 2D	IP42-rating



*\*Not all models read all codes.  
Check the specifications on  
[manhattanproducts.eu](http://manhattanproducts.eu)*

### 1D

- All UPC/EA/JA
- Code11/26/32
- Code39/93/128
- Interleave 25
- Industrial 25
- Matrix 25
- Codabar
- China Postage
- GS1 Databar
- MSI/Plessey
- LCD 25
- Telepen

### 2D

- Data Matrix
- PDF 417
- Micro PDF 417
- Maxicode
- QR code
- Aztec
- EAN.UCC composite



**Contact CCD Barcode Scanner**

[460866] 50 mm Scan Width, Wired USB, 1D, 50K Lux



**Contact CCD Barcode Scanner**

[178488] 60 mm Scan Width, Wired USB, 1D, 5K Lux



**Contact CCD Barcode Scanner**

[401517] 80 mm Scan Width, Wired USB, 1D, 3K Lux



**Laser Barcode Scanner**

[177665] 300 mm Scan Depth, Wired USB, 1D, 5K Lux

Ideal for dusty environments



**Laser Barcode Scanner**

[177429] 300 mm Scan Depth, Wired USB, 1D, 5K Lux, Rugged IP42-rated Housing



**Long Range CCD Barcode Scanner**

[177672] 500 mm Scan Depth, Wired USB, 1D, 10K Lux



**Long Range CCD Barcode Scanner**

[460835] 500 mm Scan Depth, Wired USB, 1D, 30K Lux

Ideal for dusty environments



**Linear CCD Barcode Scanner**

[178433] 500 mm Scan Depth, Wired USB, 1D, 100K Lux, Rugged IP54-rated Housing





Ideal for dusty environments

**Wireless CCD Barcode Scanner**

[178617] 500 mm Scan Depth, Wireless Range up to 80 m, 1D, 100K Lux, Rugged IP42-rated Housing



**Wireless Linear CCD Barcode Scanner**

[178495] 500 mm Scan Depth, Wireless Range up to 80 m, 1D, 100K Lux



**2D Laser Barcode Scanner**

[177603] 430 mm Scan Depth, Wired USB, 1D/2D, 100K Lux



NEW

**2D CCD Barcode Scanner**

[179775] 250 mm Scan Depth, Wired USB, 1D/2D, 100K Lux

NEW



Ideal for dusty environments

**Wireless 2D CCD Barcode Scanner**

[179768] 250 mm Scan Depth, Wireless Range up to 80 m, 1D/2D, 100K Lux, Rugged IP42-rated Housing



**Barcode Scanner Stand**

[460842] Gooseneck with Base, Compatible with models 460835, 177603 and 401517

**Smart Card Readers**



**Smart Card Reader**

USB-A, Contact Reader  
[102049] Low-profile  
[102025] Stand



**Magnetic Stripe Card Reader**

[460255] USB, Triple Track Reader

Easily expand a single USB port or interface card slot to connect and support serial modems, barcode scanners, digital cameras, card readers, Ham/Amateur Radios, GPS, CNC machines, telescopes, embroidery machines, fuel injection controllers, PDUs, network switches and other devices.



Converts a USB port into Serial/RS232/COM/DB9 ports



Plug and Play



Windows® Compatible



### MosChip MCS7840 Chipset

Model #	# of Serial Devices	USB Connection	Packaging
151047	4	A Male	Retail Box



### Prolific PL-2303RA Chipset

Model #	# of Serial Devices	USB Connection	Packaging	Length
205153	1	A Male	Bag	45 cm
205146	1	A Male	Blister	45 cm
151849	1	A Male	Bag	1.8 m
174947	2	A Male	Blister	45 cm



### FTDI FT232RL Chipset

Model #	# of Serial Devices	USB Connection	Packaging	Length
151856	1	A Male	Bag	45 cm

### Prolific PL-2303HxD Chipset

Model #	# of Serial Devices	USB Connection	Packaging	Length
151801	1	A Male	Bag	45 cm

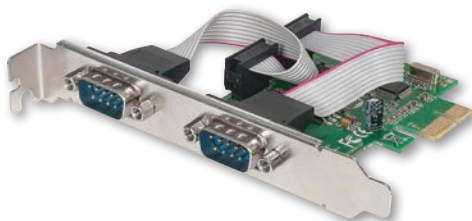

### Serial PCI Express Card

**[152082]** Two DB9 Ports; Fits PCI Express x1, x4, x8 and x16 Lane Buses

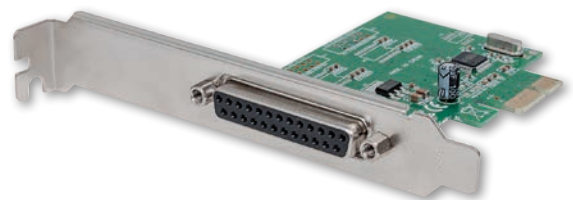

### Parallel PCI Express Card

**[152099]** One DB25 port, IEEE 1284; fits PCI Express x1, x4, x8 and x16 lane buses

Barcode	Supported Displays	Supported Size	Supported Weight (per display)	Tilt	Swivel	Rotation	Note	Mount Style	Main Material	Page
462112	1	7.9" to 10.5"	2 kg	±70°	360°	-	Tablet Stand	Stand	Steel	123
462105	1	9.7" to 10.5"	2 kg	-	-	-	Tablet Wall Mount	Wall/VESA	Steel	123
462228	1	9.7" to 10.5"	2 kg	-	-	-	Tablet Wall Mount	Wall/VESA	Steel	123
462129	1	10" to 15.6"	5 kg	5 levels	-	-	Laptop Stand	Stand	Steel	123
462211	1	11" to 17"	4 kg	-	-	-	VESA Mount Laptop Holder	VESA	Steel	123
422840	1	13" to 22"	15 kg	-	-	-	Ultra Slim	Wall	Steel	96
432351	1	13" to 22"	12 kg	±90°	±90°	360°	Single-Jointed Arm	Wall	Steel	102
420808	2	13" to 24"	6 kg	±90°	±90°	180°	Double-Jointed Arm	Desk Clamp	Steel	90
461658	3	13" to 27"	7 kg	±90°	±90°	±180°	Double-Jointed Arm	Desk Clamp	Steel	91
423700	1	13" to 27"	15 kg	±15°	180°	-	Single-Jointed Arm	Wall	Steel	103
423670	1	13" to 27"	15 kg	±15°	±180°	-	Double-Jointed Arm	Wall	Steel	103
460958	1	13" to 27"	15 kg	±70°	±90°	-	Double-Jointed Arm	Wall	Aluminum	103
461382	1	13" to 27"	20 kg	+5° to -12°	±90°	-	Double-Jointed Arm	Wall	Steel	104
462136	1	13" to 32"	8 kg	+90° / -35°	180°	360°	Combo for Monitor & Laptop	Desk Clamp	Steel	90
461542	1	13" to 32"	8 kg	±45°	±90°	360°	Double-Jointed Arm	Desk Clamp	Steel	89
461528	2	13" to 32"	8 kg	±45°	±90°	180°	Double-Jointed Arm	Desk Clamp	Steel	90
461559	2	13" to 32"	8 kg	±45°	±90°	180°	Double-Jointed Arm	Stand	Steel	89
461566	4	13" to 32"	8 kg	±45°	±90°	±180°	Double-Jointed Arm	Desk Clamp	Steel	91
461788	1	13" to 32"	15 kg	90°	±180°	-	Portable Tripod with Tray	Stand	Steel	113
423717	1	13" to 32"	20 kg	-15° to 10°	-	-	-	Wall	Steel	98
462037	1	17" to 32"	7 kg	±10°	±45°	±90°	-	Stand	Steel	89
461573	1	17" to 32"	8 kg	±35°	±90°	±180°	Gas Spring, Single-Jointed Arm	Desk Clamp	Steel	93
461603	1	17" to 32"	8 kg	±35°	±90°	±180°	Gas Spring, Single-Jointed Arm	Wall	Steel	95
461580	1	17" to 32"	8 kg	±35°	±90°	±180°	Gas Spring, Double-Jointed Arm	Desk Clamp	Steel	93
461610	1	17" to 32"	8 kg	±35°	±90°	±180°	Gas Spring, Double-Jointed Arm	Wall	Steel	95
461597	2	17" to 32"	8 kg	±35°	±90°	±180°	Gas Spring, Double-Jointed Arm	Desk Clamp	Steel	93
461627	2	17" to 32"	8 kg	±35°	±90°	±180°	Gas Spring, Double-Jointed Arm	Wall	Steel	95
461399	1	13" to 42"	20 kg	+5° to -12°	±90°	-	Single-Jointed Arm	Wall	Steel	105
461405	1	13" to 42"	20 kg	+5° to -12°	±45°	-	Double-Jointed Arm	Wall	Steel	105
423731	1	23" to 42"	30 kg	-	-	-	Low-Profile	Wall	Steel	96
423755	1	23" to 42"	20 kg	±15	±180°	-	Double-Jointed Arm	Wall	Aluminum	105
460934	1	32" to 55"	40 kg	-	-	-	Low-Profile	Wall	Steel	97
460941	1	32" to 55"	35 kg	0° to -14°	-	-	-	Wall	Steel	98
461320	1	32" to 55"	35 kg	+10° to -15°	±90°	-	-	Wall	Steel	107
461344	1	32" to 55"	40 kg	-15° to 5°	±60°	-	±3° Level Adjustment	Wall	Steel	107
461252	1	32" to 55"	50 kg	-20° to 10°	180°	-	-	Wall	Steel	107
461306	1	32" to 55"	50 kg	-15° to 5°	±60°	-	±2.5° Level Adjustment	Wall	Aluminum	108
461474	1	32" to 55"	80 kg	-10° to 5°	-	-	Post-Leveling Adjustment	Wall	Steel	98
461641	1	21" to 60"	30 kg	±10°	±90°	-	Gas Spring Mount	Wall	Steel	96
461214	1	37" to 63"	60 kg	±15°	120°	-	Allows Corner Mounting	Wall	Steel	109
461795	1	45" to 65"	32 kg	-	±180°	-	Portable Tripod	Stand	Aluminum	114
462044	1	32" to 70"	40 kg	-10° to 3°	-	-	Ultra Slim, Portable	Stand	Aluminum	115
423625	1	37" to 70"	50 kg	0° to -15°	360°	-	Ceiling mount	Ceiling	Steel	112
462204	1	37" to 70"	50 kg	0° to 25°	360°	-	Ceiling mount	Ceiling	Steel	112
461412	1	37" to 70"	35 kg	-8° to -15°	-	-	Portable Tripod	Stand	Steel	113
461979	1	37" to 70"	35 kg	0° to 8°	-	-	Ultra Slim	Wall	Steel	99
461467	1	37" to 70"	35 kg	±12°	-	-	Integrated Storage Area	Wall	Steel	99
461337	1	37" to 70"	35 kg	+10° to -15°	±90°	-	-	Wall	Steel	109
461351	1	37" to 70"	40 kg	-15° to 5°	±60°	-	±3° Level Adjustment	Wall	Steel	109
461986	1	37" to 70"	50 kg	-	-	-	Ultra Slim, Heavy-Duty	Wall	Steel	97
461283	1	37" to 70"	50 kg	-20 to +10°	±90°	-	-	Wall	Steel	110
424752	1	37" to 70"	75 kg	0° to -10°	-	-	-	Wall	Steel	99
461238	1	37" to 70"	50 kg	±10°	-	-	TV Cart	Cart	Steel	117
461245	1	37" to 70"	50 kg	-12° to +5	-	-	TV Cart	Cart	Aluminum	118
461719	1	45" to 70"	70 kg	-5° to 3°	-	-	Premium Video-Wall TV Mount	Wall	Steel	100
461481	1	37" to 80"	80 kg	-10° to +5	-	-	Post-Leveling Adjustment	Wall	Steel	102
423830	1	37" to 85"	75 kg	±10°	-	-	-	Wall	Steel	102
461290	1	37" to 90"	75 kg	±60°	-	-	±3° Level Adjustment	Wall	Steel	111
461665	1	37" to 100"	150 kg	-	-	-	Heavy-Duty TV Cart	Cart	Steel	119
461221	1	60" to 100"	80 kg	-15° to 5°	±45°	-	±3° level adjustment	Wall	Steel	111
461993	1	60" to 100"	100 kg	-	-	-	Ultra Slim	Wall	Steel	87
461672	1	60" to 100"	100 kg	-10 to 5°	-	-	Heavy-Duty TV Cart	Cart	Aluminum	120

Please note: The size capacity of all mounts is just an approximate guideline. The VESA compliance and weight capacity determine the actual support.

# Monitor Desk Stands and Mounts

Position your monitor(s) ergonomically above the desktop to increase work space, reduce eye strain and improve posture



**Detachable VESA Plate**  
enables easy installation

*Shown: 461658*

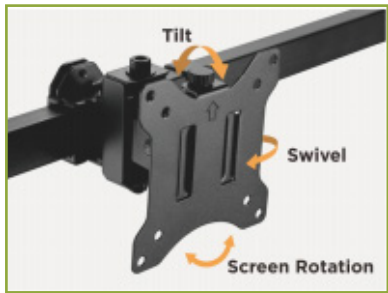
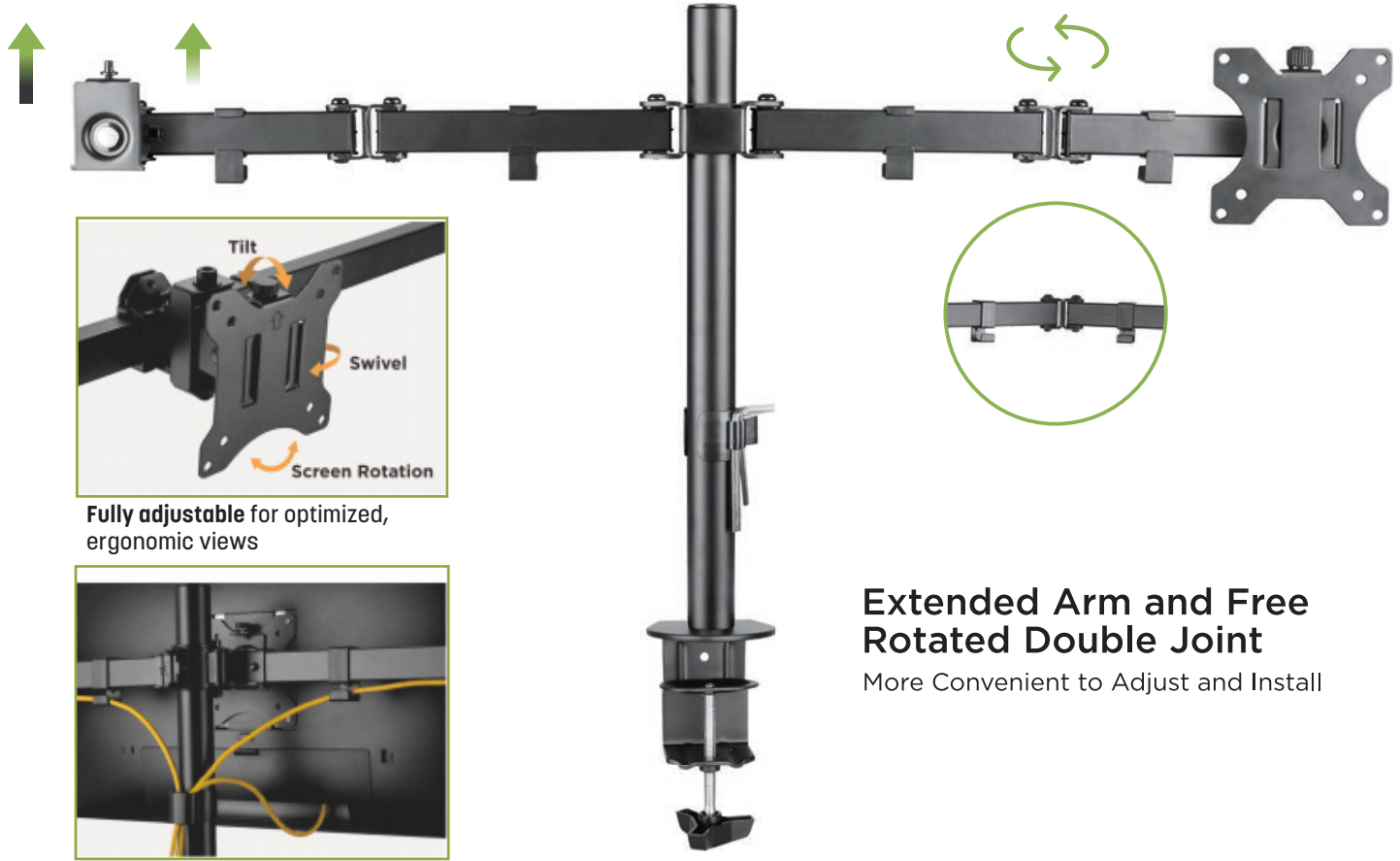

**Fully adjustable** for optimized, ergonomic views



**Built-in cable management** to minimize clutter

**Extended Arm and Free Rotated Double Joint**

More Convenient to Adjust and Install

## Individual Height Adjustment

helps monitors to be perfectly aligned







**NEW**

### Single Monitor Desktop Stand

[462037]

- Detachable VESA Plate Design: enables easy installation
- 360° Rotary VESA Plate: for more viewing experience
- Freely Adjusting Height: for an optimal ergonomic position
- Cable Management: keep everything organized
- Sturdy Steel Construction: provides a solid and long-lasting performance

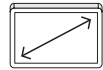

Screen Size  
17"-27"



Weight Capacity  
7kg

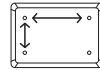

VESA Compatible  
75x75 100x100



Tilt Range  
+10°--10°



Swivel Range  
+45°--45°



Screen Rotation  
360°

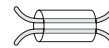

Cable Management



### Dual Monitor Desktop Stand

[461559]

- Detachable VESA Plate Design: enables easy installation
- 360° Rotary VESA Plate: for more viewing experience
- Freely Adjusting Height: for an optimal ergonomic position
- Extended arm and free rotated double joint
- Cable Management: keep everything organized
- Sturdy Steel Construction: provides a solid and long-lasting performance



Screen Size  
13"-32"



Weight Capacity  
8kg/17.6lbs



VESA Compatible  
75x75 100x100



Tilt Range  
+45°--45°

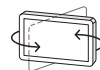

Swivel Range  
+90°--90°



Screen Rotation  
360°

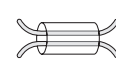

Cable Management



Clamp or  
grommet installation

### Single Monitor Desk Mount

[461542]

- Detachable VESA Plate Design: enables easy installation
- Cable Management: keep everything organized
- 360° Rotary VESA Plate: for more viewing experience
- Extended arm and free rotated double joint
- Two Mounting Options: both desk clamp and grommet are included
- Freely Adjusting Height: for an optimal ergonomic position

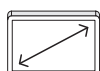

Screen Size  
13"-32"



Weight Capacity  
8kg/17.6lbs

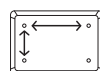

VESA Compatible  
75x75 100x100



Tilt Range  
+45°--45°

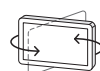

Swivel Range  
+90°--90°



Screen Rotation  
360°

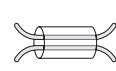

Cable Management



- Detachable VESA Plate Design: enables easy installation
- Cable Management: keep everything organized
- 360° Rotary VESA Plate: for more viewing experience
- Supports 10" to 17" Notebook up to 8 kg (17 lbs.)
- Adjusting Height: for an optimal ergonomic position
- Sturdy Steel Construction: provides a solid and long-lasting performance



### Monitor Desk Mount with Laptop Holder

[462136]



Screen Size  
13"-32"



Weight Capacity  
8kg/17.6lbs



VESA Compatible  
75x75 100x100



Tilt Range  
+90°--35°

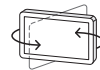

Swivel Range  
+90°--90°



Screen Rotation  
360°

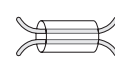

Cable Management

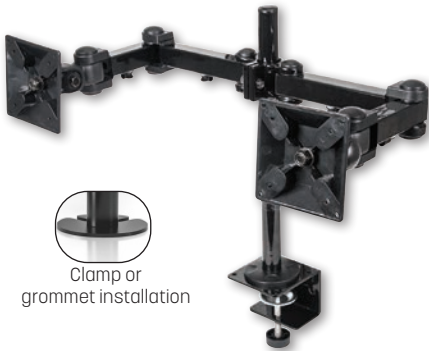

- Cable Management: keep everything organized
- 360° Rotary VESA Plate: for more viewing experience
- Extended arm and free rotated double joint
- Freely Adjusting Height: for an optimal ergonomic position

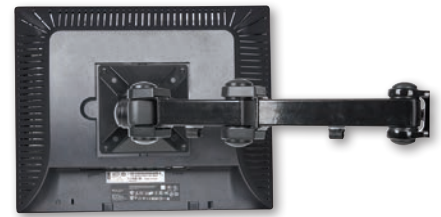

### Dual Monitor Desk Mount

[420808]

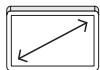

Screen Size  
13"-24"



Weight Capacity  
6kg/13lbs

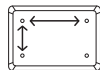

VESA Compatible  
75x75 100x100



Tilt Range  
+90°--90°

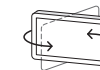

Swivel Range  
+90°--90°



Screen Rotation  
360°

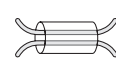

Cable Management

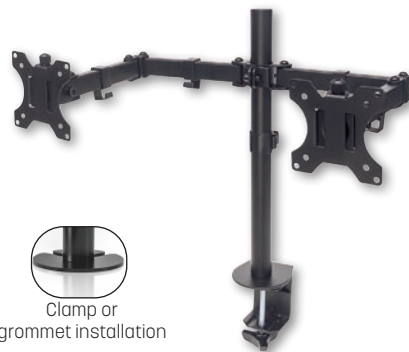

- Detachable VESA Plate Design: enables easy installation
- Cable Management: keep everything organized
- 360° Rotary VESA Plate: for more viewing experience
- Extended arm and free rotated double joint
- Two Mounting Options: both desk clamp and grommet are included
- Freely Adjusting Height: for an optimal ergonomic position



### Dual Monitor Desk Mount

[461528]



Screen Size  
13"-32"



Weight Capacity  
8kg/17.6lbs



VESA Compatible  
75x75 100x100



Tilt Range  
+45°--45°

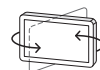

Swivel Range  
+90°--90°



Screen Rotation  
360°

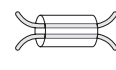

Cable Management

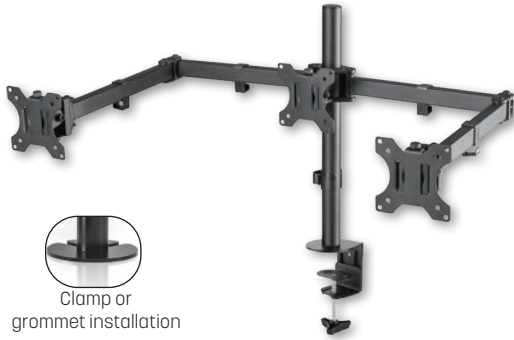

- Detachable VESA Plate Design: enables easy installation
- Cable Management: keep everything organized
- 360° Rotary VESA Plate: for more viewing experience
- Extended arm and free rotated double joint
- Two Mounting Options: both desk clamp and grommet are included
- Freely Adjusting Height: for an optimal ergonomic position

**Triple Monitor Desk Mount**

[461658]

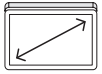

Screen Size  
**13"-32"**



Weight Capacity  
**8kg/17.6lbs**

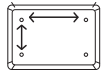

VESA Compatible  
**75x75 100x100**



Tilt Range  
**+45°~-45°**

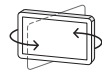

Swivel Range  
**+90°~-90°**

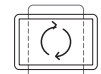

Screen Rotation  
**360°**

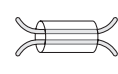

Cable Management



**Perfectly Aligned Displays**



- Detachable VESA Plate Design: enables easy installation
- Cable Management: keep everything organized
- 360° Rotary VESA Plate: for more viewing experience
- Extended arm and free rotated double joint
- Two Mounting Options: both desk clamp and grommet are included
- Freely Adjusting Height: for an optimal ergonomic position



**Quad Monitor Desk Mount**

[461566]

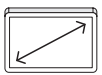

Screen Size  
**13"-32"**



Weight Capacity  
**8kg/17.6lbs**

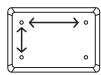

VESA Compatible  
**75x75 100x100**



Tilt Range  
**+45°~-45°**

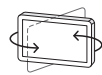

Swivel Range  
**+90°~-90°**

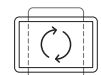

Screen Rotation  
**360°**

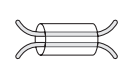

Cable Management

# Gas Spring Desk Mounts

Light-touch full-motion adjustment for the best ergonomic viewing angle



Shown: 461597

## High-Quality Aluminum Construction



Shown: 461580



Desk clamp and grommet hole mounting options firmly hold your monitor.



Quick-Release VESA Plate for easy installation

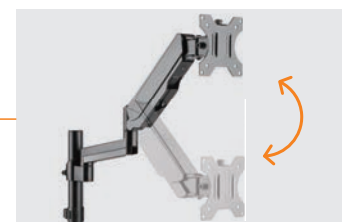

Adjustable Gas Pressure accommodates smooth adjustment for different weight of monitors.

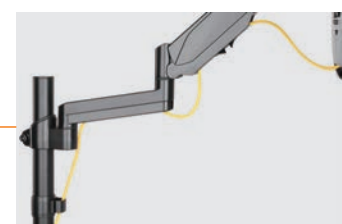

Cable Management creates a clutter-free desktop.





- Gas spring perfectly counterbalances the weight of your screen to help effortless adjustment for viewing comfort
- Swiveling Arm(s): offer(s) maximum viewing flexibility
- Lightweight Aluminum Construction: provides a sleek, lighter, and elegant look
- Detachable VESA Plate Design: enables easy installation
- Free-Tilting Design: makes easy forward or backward adjustment for better viewing and reduced glare
- Cable Management: keep everything organized
- 360° Rotary VESA Plate: for more viewing experience



**Aluminum Gas Spring Single Monitor Desk Mount**

[461573]

Screen Size 17"-32"	VESA Compatible 75x75 100x100	Screen Rotation 360°	Tilt Range +35°--35°	Swivel Range +90°--90°	Weight Capacity 1-9kg/2.2-19.8lbs	



- Gas spring perfectly counterbalances the weight of your screen to help effortless adjustment for viewing comfort
- Swiveling Arm(s): offer(s) maximum viewing flexibility
- Lightweight Aluminum Construction: provides a sleek, lighter, and elegant look
- Detachable VESA Plate Design: enables easy installation
- Free-Tilting Design: makes easy forward or backward adjustment for better viewing and reduced glare
- Cable Management: keep everything organized
- 360° Rotary VESA Plate: for more viewing experience

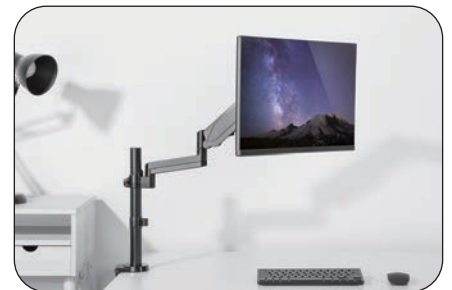

**Aluminum Gas Spring Single Monitor Desk Mount**

[461580]

Screen Size 17"-32"	VESA Compatible 75x75 100x100	Screen Rotation 360°	Tilt Range +35°--35°	Swivel Range +90°--90°	Weight Capacity 1-9kg/2.2-19.8lbs	

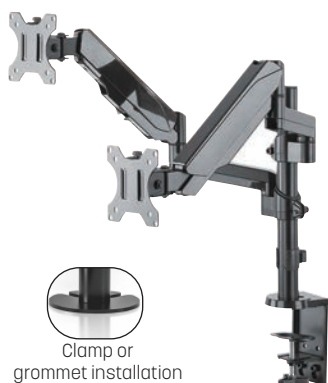

- Gas spring perfectly counterbalances the weight of your screen to help effortless adjustment for viewing comfort
- Swiveling Arm(s): offer(s) maximum viewing flexibility
- Lightweight Aluminum Construction: provides a sleek, lighter, and elegant look
- Detachable VESA Plate Design: enables easy installation
- Free-Tilting Design: makes easy forward or backward adjustment for better viewing and reduced glare
- Cable Management: keep everything organized
- 360° Rotary VESA Plate: for more viewing experience



**Aluminum Gas Spring Dual Monitor Desk Mount**

[461597]

Screen Size 17"-32"	VESA Compatible 75x75 100x100	Screen Rotation 360°	Tilt Range +35°--35°	Swivel Range +90°--90°	Weight Capacity 1-9kg/2.2-19.8lbs (x2)	

# Gas Spring Wall Mounts

Light-touch full-motion adjustment for the best ergonomic viewing angle



They're all about being easy to use



**Adjustable gas pressure** accommodates smooth adjustment for different weight of monitors.

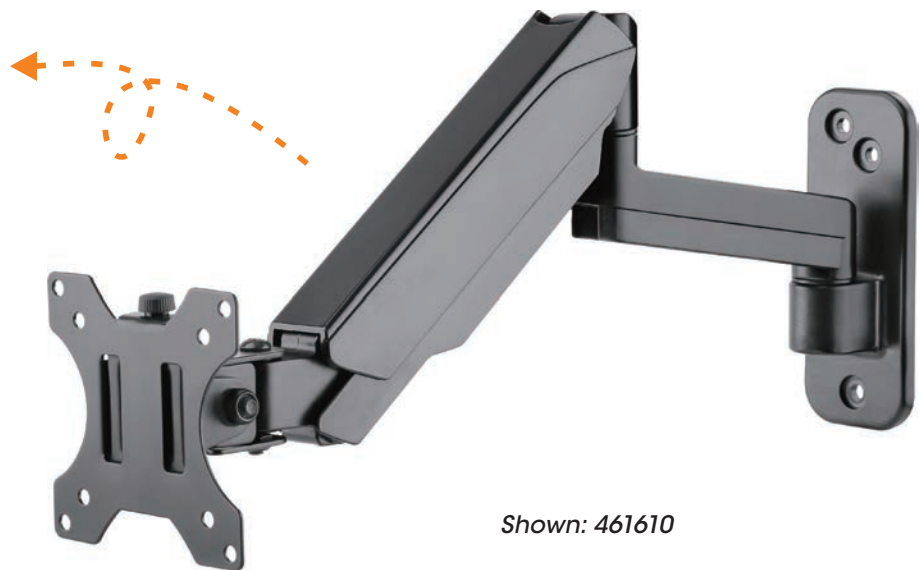

**Three mounting holes** are easy for installation, and securely holds your monitor.



**Quick-release VESA plate** for easy installation

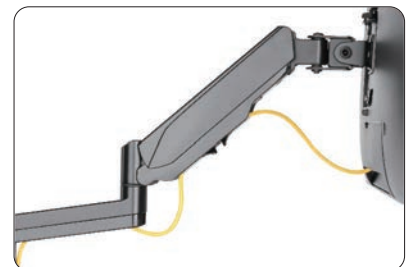

**Cable management** creates a clutter-free desktop.



- Gas spring perfectly counterbalances the weight of your screen to help effortless adjustment for viewing comfort
- Swiveling Arm(s): offer(s) maximum viewing flexibility
- Lightweight Aluminum Construction: provides a sleek, lighter, and elegant look
- Detachable VESA Plate Design: enables easy installation
- Free-Tilting Design: makes easy forward or backward adjustment for better viewing and reduced glare
- Cable Management: keep everything organized
- 360° Rotary VESA Plate: for more viewing experience



### Aluminum Gas Spring Single Monitor Wall Mount

[461603]



Screen Size  
17"-32"



Tilt Range  
+35°--35°

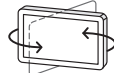

Swivel Range  
+90°--90°



Weight Capacity  
1-9kg/2.2-19.8lbs



Screen Rotation  
+180°--180°

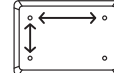

VESA Compatible  
75x75 100x100

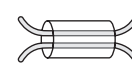

Cable Management



- Gas spring perfectly counterbalances the weight of your screen to help effortless adjustment for viewing comfort
- Swiveling Arm(s): offer(s) maximum viewing flexibility
- Lightweight Aluminum Construction: provides a sleek, lighter, and elegant look
- Detachable VESA Plate Design: enables easy installation
- Free-Tilting Design: makes easy forward or backward adjustment for better viewing and reduced glare
- Cable Management: keep everything organized
- 360° Rotary VESA Plate: for more viewing experience



### Aluminum Gas Spring Single Monitor Wall Mount

[461610]



Screen Size  
17"-32"



Tilt Range  
+35°--35°

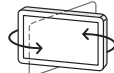

Swivel Range  
+90°--90°



Weight Capacity  
1-9kg/2.2-19.8lbs



Screen Rotation  
180° 180°

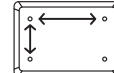

VESA Compatible  
75 75 100 100

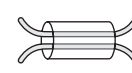

Cable Management

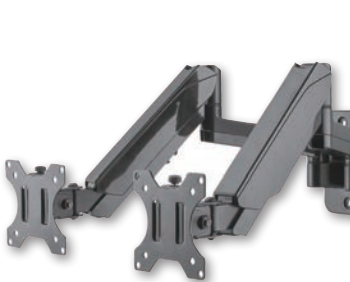

- Gas spring perfectly counterbalances the weight of your screen to help effortless adjustment for viewing comfort
- Swiveling Arm(s): offer(s) maximum viewing flexibility
- Lightweight Aluminum Construction: provides a sleek, lighter, and elegant look
- Detachable VESA Plate Design: enables easy installation
- Free-Tilting Design: makes easy forward or backward adjustment for better viewing and reduced glare
- Cable Management: keep everything organized
- 360° Rotary VESA Plate: for more viewing experience

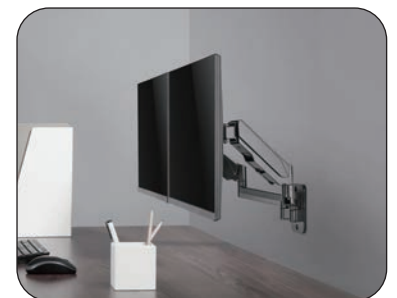

### Aluminum Gas Spring Dual Monitor Wall Mount

[461627]



Screen Size  
17"-32"



Tilt Range  
+35°--35°

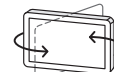

Swivel Range  
+90°--90°



Weight Capacity  
1-9kg/2.2-19.8lbs (x2)



Screen Rotation  
+180°--180°



VESA Compatible  
75x75 100x100



Cable Management



- Gas spring perfectly counterbalances the weight of your screen to help effortless adjustment for viewing comfort
- Built-in Spring Tension Gauge: for perfect weight adjustments
- Sturdy Steel Construction: provides a solid and long-lasting performance
- Cable Management: keep everything organized
- Decorative Covers: for a more elegant look



### Gas Spring Full-Motion TV Wall Mount

[461641]

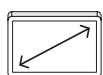

Screen Size  
21"-60"

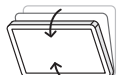

Tilt Range  
+10°~-10°

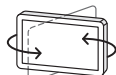

Swivel Range  
+90°~-90°



Weight Capacity  
30 kg



Screen Rotation  
+180°~-180°

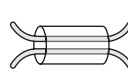

Cable Management

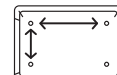

VESA Compatible  
75x75, 100x100, 200x100,  
200x200, 300x300, 400x400



- Ultra-slim design
- Sturdy Steel Construction: provides a solid and long-lasting performance
- Easy installation ideal for home, office and commercial applications
- Integrated Bubble Level: assures alignment



### Compact Slim Fixed Monitor Wall Mount

[422840]



Screen Size  
13"-22"



Weight Capacity  
15 kg

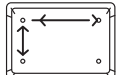

VESA Compatible  
75x75, 100x100

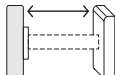

Profile to Wall  
25 mm



- Ultra-slim design
- Sturdy Steel Construction: provides a solid and long-lasting performance
- Easy installation ideal for home, office and commercial applications
- Integrated Bubble Level: assures alignment



**Extends only 14 mm from the wall**

### Ultra-Slim Fixed Monitor Wall Mount

[423731]

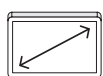

Screen Size  
23"-42"



Weight Capacity  
30 kg

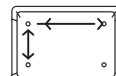

VESA Compatible  
75x75, 100x100, 200x200

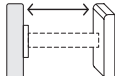

Profile to Wall  
14 mm





- Sturdy Steel Construction: provides a solid and long-lasting performance
- Open Architecture: provides increased ventilation and easier access to wires
- Low Profile: ensures TV is close to the wall for a sleek finish (works well with ultra-thin flat panel TVs)



**Extends only 25 mm from the wall**

### Low-Profile Fixed TV Wall Mount

[460934]

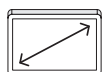

Screen Size  
32"-55"



Weight Capacity  
40 kg

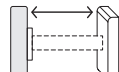

Profile to Wall  
25 mm

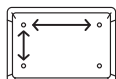

VESA Compatible  
200x200, 300x300,  
400x200, 400x400



**NEW**

- Sturdy Steel Construction: provides a solid and long-lasting performance
- Automatically Click-in Spring Lock: helps TV brackets snap into place for added safety
- Lateral Shift Brackets: enable width adjustment and fast alignment
- Intuitive quick release cords: allow to remove TV from the mount easily and quickly
- Includes attachable bubble level



**Extends only 25 mm from the wall**

### Heavy-Duty Low-Profile Fixed TV Wall Mount

[461986]

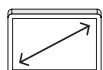

Screen Size  
37"-70"



Weight Capacity  
50 kg

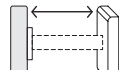

Profile to Wall  
25 mm

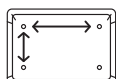

VESA Compatible  
200x200, 300x300,  
400x200, 400x400, 600x400



**NEW**

- Sturdy Steel Construction: provides a solid and long-lasting performance
- Automatically Click-in Spring Lock: helps TV brackets snap into place for added safety
- Lateral Shift Brackets: enable width adjustment and fast alignment
- Intuitive release cords
- Includes attachable bubble level

### XL Heavy-Duty Low-Profile Fixed TV Wall Mount

[461993]

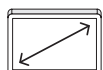

Screen Size  
60"-100"



Weight Capacity  
100 kg

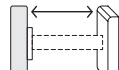

Profile to Wall  
32 mm

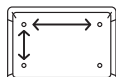

VESA Compatible  
200x200, 300x300, 400x200, 400x400,  
600x400, 800x400, 800x600, 900x600



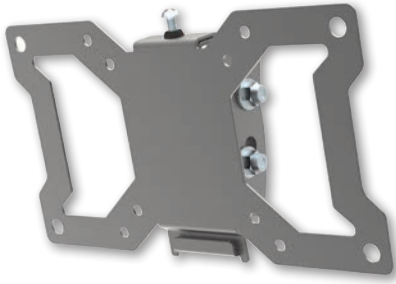

- Sturdy Steel Construction: provides a solid and long-lasting performance
- Easy installation ideal for home, office and commercial applications
- Optimize views with -15° to 10° tilt adjustment
- Provides effortless adjustment of viewing angle without the use of tools

### Slim Tilting Display Wall Mount

[423717]

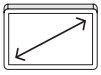

Screen Size  
13"-32"



Weight Capacity  
20 kg



Tilt Range  
+10°~-15°

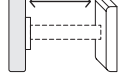

Profile to Wall  
36 mm

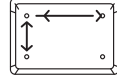

VESA Compatible  
75x75, 100x100 or 200x100



- Sturdy Steel Construction: provides a solid and long-lasting performance
- Free-Tilting Design: makes easy forward or backward adjustment for better viewing and reduced glare
- Open Architecture: provides increased ventilation and easier access to wires



**Extends only 36 mm from the wall**

### Low-Profile Tilting TV Wall Mount

[460941]

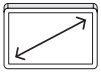

Screen Size  
32"-55"



Weight Capacity  
35 kg

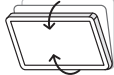

Tilt Range  
0°~14°

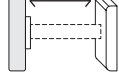

Profile to Wall  
36 mm

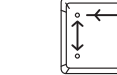

VESA Compatible  
200x200, 300x300, 400x200 & 400x400



- Sturdy Steel Construction: provides a solid and long-lasting performance
- Toolless Tilt: allows for effortless positioning
- Open Architecture: provides increased ventilation and easier access to wires
- Easy installation ideal for home, office and commercial applications



### Heavy-Duty Tilting TV Wall Mount

[461474]

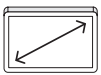

Screen Size  
32"-55"



Weight Capacity  
80 kg



Tilt Range  
-10°~-5°

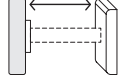

Profile to Wall  
53 mm



Screen Level  
+3°~-3°

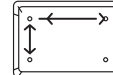

VESA Compatible  
200x200, 300x300, 400x200 & 400x400



**NEW**

- **Sturdy Steel Construction:** provides a solid and long-lasting performance
- **Easy installation** ideal for home, office and commercial applications
- **Open Architecture:** provides increased ventilation and easier access to wires
- **TV brackets snap into place** for add safety with security screws.

**Extends only 21 mm from the wall**

**Low-Profile Tilting TV Wall Mount**

[461979]

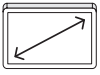

Screen Size  
37"-70"



Weight Capacity  
35 kg



Tilt Range  
0°~8°

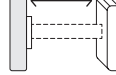

Profile to Wall  
21 mm

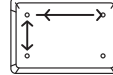

VESA Compatible  
200x200, 300x300,  
400x200, 400x400, 600x400

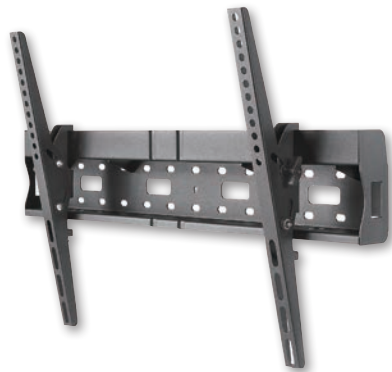

- **Sturdy Steel Construction:** provides a solid and long-lasting performance
- **Ample Space:** large enough to hold media players
- **Open Architecture:** provides increased ventilation and easier access to wires
- **Bubble level included**
- **Security Screws:** hold TV securely to the wall plate
- **Easy-Grip Knobs:** for quick tilt and lock

**Tilting TV Wall Mount with Integrated Storage Area**

[461467]

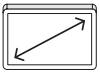

Screen Size  
37"-70"



Weight Capacity  
35 kg



Tilt Range  
-12°~+12°

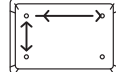

VESA Compatible  
200x200, 300x200, 400x200,  
300x300, 400x300, 400x400, 600x400



- **Sturdy Steel Construction:** provides a solid and long-lasting performance
- **Easy-Grip Knobs:** for quick tilt and lock
- **Open Architecture:** provides increased ventilation and easier access to wires
- **Integrated Bubble Level:** assures alignment

**Heavy-Duty Tilting TV Wall Mount**

[424752]

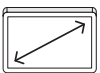

Screen Size  
37"-70"



Weight Capacity  
75 kg

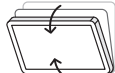

Tilt Range  
0°~+10°

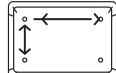

VESA Compatible  
200x200, 400x200,  
300x300, 400x400, 600x400

# Video Wall Premium TV Mount

Securely holds one flat-panel TV for a video-wall installation

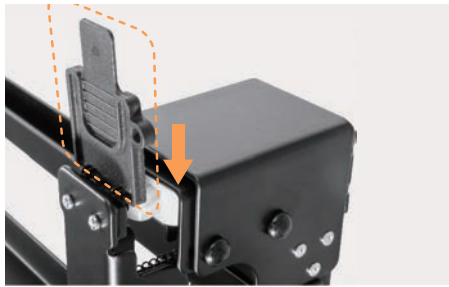

**Pop-Out Lock System** reduces the possibility of accidental pop-outs



**Lock & Unlock Switch Knob** helps to lock/release display out of the wall plate

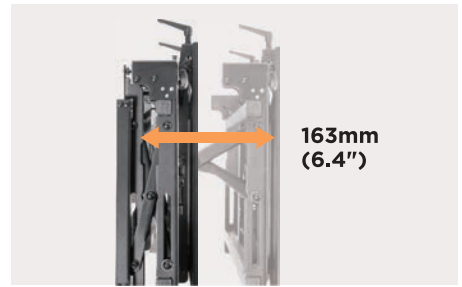

**Pop-Out Extension** easily pulls out for installation and maintenance

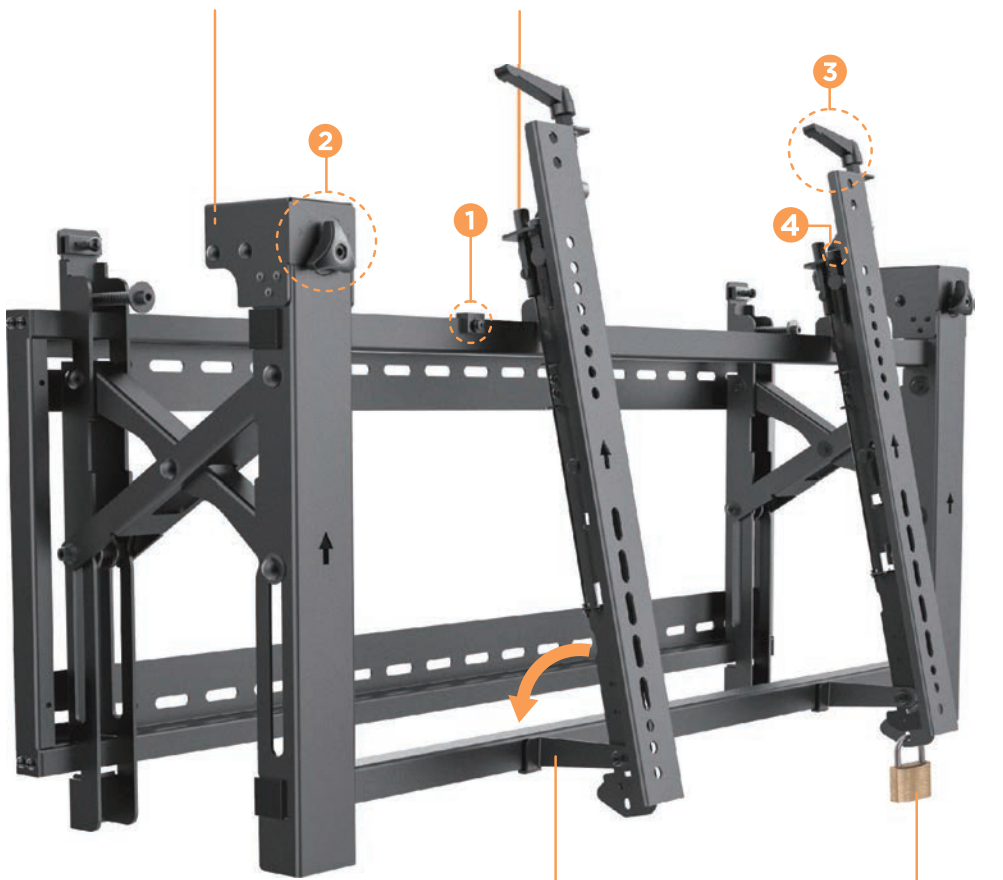

**Kick-Stand Design** provides 12° tilt for cable management and maintenance

**Anti-Theft Design** (padlock required)

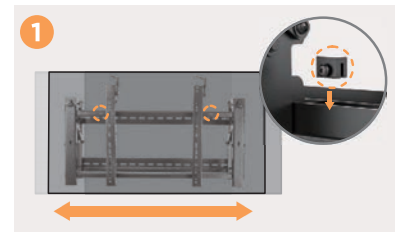

**Lateral Shift** allows screens to slide left/right to simplify installation and also can be fixed to prevent potential collisions

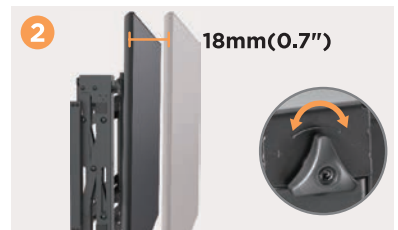

**Rotary Knobs** offer fine-tuning of depth from the wall

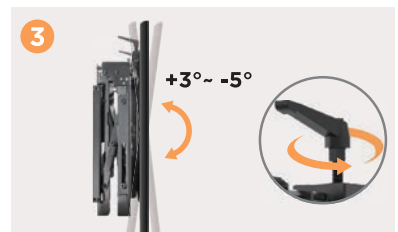

**Adjustment Handles** enable easy tilting



**Height Adjustment** ensures perfect alignment





### Premium Video-Wall Tilting TV Wall Mount

[461719]

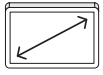

Screen Size  
45"-70"



Weight Capacity  
70 kg

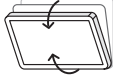

Tilt Range  
+3°~-5°

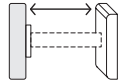

Profile to Wall  
143 - 306 mm

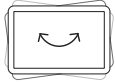

Screen Level  
+3°~-3°



Anti-Theft



Direction  
Indicator

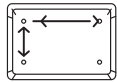

VESA Compatible  
200x200, 300x300, 400x200,  
400x400, 600x400

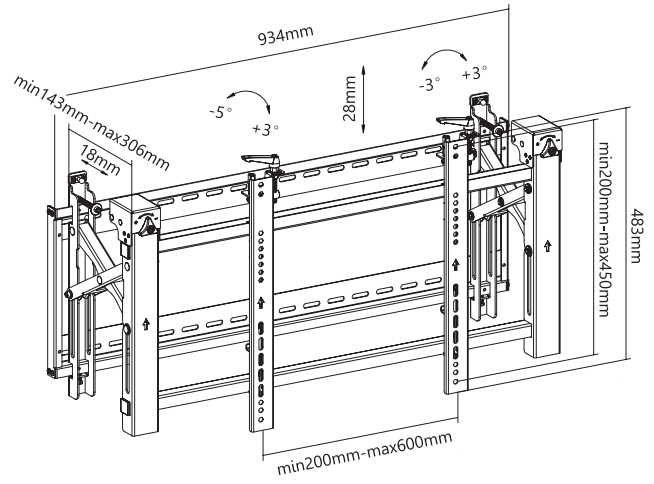



- Sturdy Steel Construction: provides a solid and long-lasting performance
- Toolless Tilt: allows for effortless positioning
- Open Architecture: provides increased ventilation and easier access to wires
- Easy installation ideal for home, office and commercial applications



### Heavy-Duty Tilting TV Wall Mount

[461481]

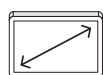

Screen Size  
37"-80"



Weight Capacity  
80 kg

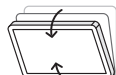

Tilt Range  
-10°~5°

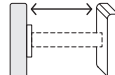

Profile to Wall  
53 mm



Screen Level  
+3°~-3°

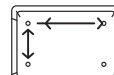

VESA Compatible  
200x200, 400x200,  
300x300, 400x400, 600x400



- Sturdy Steel Construction: provides a solid and long-lasting performance
- Easy-Grip Knobs: for quick tilt and lock
- Open Architecture: provides increased ventilation and easier access to wires
- Integrated Bubble Level: assures alignment



### Heavy-Duty Tilting TV Wall Mount

[423830]

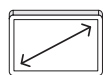

Screen Size  
37"-85"



Weight Capacity  
75 kg

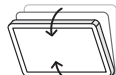

Tilt Range  
-10°~10°

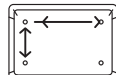

VESA Compatible  
200x200, 400x200,  
300x300, 400x400, 600x400



- Sturdy Steel Construction: provides a solid and long-lasting performance
- Easy-Grip Knobs: for quick tilt and lock
- Swiveling Arm(s): offer(s) maximum viewing flexibility
- 360° Rotary VESA Plate: for more viewing experience
- Easy installation ideal for home, office and commercial applications



### Articulating Monitor Wall Mount

[432351]

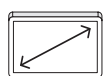

Screen Size  
13"-22"



Weight Capacity  
12 kg



Tilt Range  
+90°~-90°

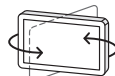

Swivel Range  
+90°~-90°



Screen Rotation  
+180°~-180°

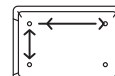

VESA Compatible  
75x75, 100x100



- Anti-Theft Locking Hole: for additional security preventing any unwanted removal (extra padlock required)
- Lightweight Aluminum Construction: provides a sleek, lighter, and elegant look
- Swiveling Arm(s): offer(s) maximum viewing flexibility
- Slide-in VESA Plate: for quick attachment and detachment
- Easy installation ideal for home, office and commercial applications
- 360° Rotary VESA Plate: for more viewing experience
- Cable Management: keep everything organized



**Aluminum Full-Motion Display Wall Mount**

[423700] Single-Link Swing Arm  
[423670] Double-Link Swing Arm

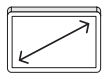

Screen Size  
13"-27"



Weight Capacity  
15 kg



Tilt Range  
+15°~-15°

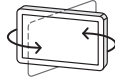

Swivel Range  
+90°~-90°



Screen Rotation  
+180°~-180°



Anti-Theft

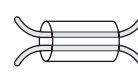

Cable Management

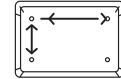

VESA Compatible  
75x75, 100x100

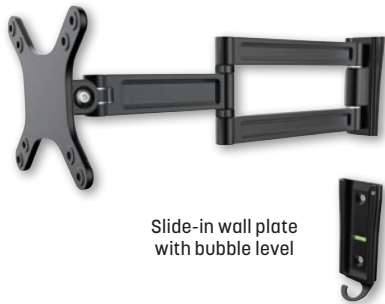

Slide-in wall plate with bubble level

- Free-Tilting Design: makes easy forward or backward adjustment for better viewing and reduced glare
- Built-In Level Adjustment: ensures perfect positioning
- Direction Indicator: assures correct installation
- Swiveling Arm(s): offer(s) maximum viewing flexibility
- Sturdy Steel Construction: provides a solid and long-lasting performance
- Cable Management: keep everything organized
- Detachable VESA Plate Design: enables easy installation



**Aluminum Full-Motion Display Wall Mount**

[460958]

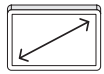

Screen Size  
13"-27"



Weight Capacity  
15 kg



Tilt Range  
+70°~-70°

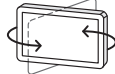

Swivel Range  
+90°~-90°



Screen Rotation  
+180°~-180°



Anti-Theft

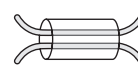

Cable Management

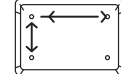

VESA Compatible  
75x75, 100x100

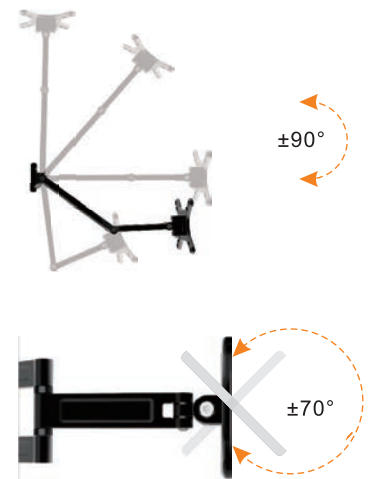



# Full-motion TV Wall Mounts

Display arms with maximum flexibility for recommended screen sizes up to 42"



Shown: 461382

**Detachable VESA Plate Design**  
enables easy installation

**Free-Tilting Design**  
for multiple monitor viewing angles  
 $+5^{\circ}$   $-12^{\circ}$

**Built-In Level Adjustment**  
ensures perfect positioning

**Cable Management**  
keeps everything organized

$\pm 180^{\circ}$



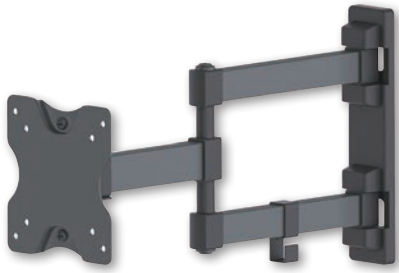

- Free-Tilting Design: makes easy forward or backward adjustment for better viewing and reduced glare
- Built-In Level Adjustment: ensures perfect positioning
- Direction Indicator: assures correct installation
- Swiveling Arm(s): offer(s) maximum viewing flexibility
- Sturdy Steel Construction: provides a solid and long-lasting performance
- Cable Management: keep everything organized
- Detachable VESA Plate Design: enables easy installation



### Full-Motion TV Wall Mount

[461382]

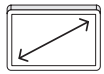

Screen Size  
13"-27"



Weight Capacity  
20 kg



Tilt Range  
+5°~-12°

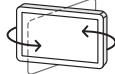

Swivel Range  
+90°~-90°



Screen Level  
+3°~-3°

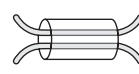

Cable  
Management

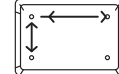

VESA Compatible  
75x75, 100x100



- Free-Tilting Design: makes easy forward or backward adjustment for better viewing and reduced glare
- Built-In Level Adjustment: ensures perfect positioning
- Direction Indicator: assures correct installation
- Swiveling Arm(s): offer(s) maximum viewing flexibility
- Sturdy Steel Construction: provides a solid and long-lasting performance
- Cable Management: keep everything organized
- Detachable VESA Plate Design: enables easy installation

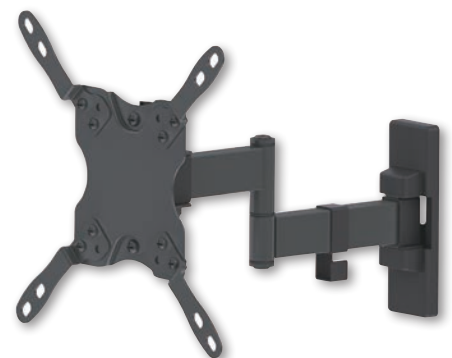

### Full-Motion Display Wall Mount

[461399] Single-Link Swing Arm

[461405] Double-Link Swing Arm

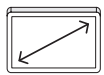

Screen Size  
13"-42"



Weight Capacity  
20 kg



Tilt Range  
+5°~-12°

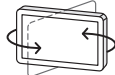

Swivel Range  
+90°~-90°



Screen Level  
+3°~-3°

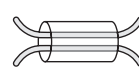

Cable  
Management

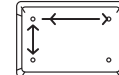

VESA Compatible  
75x75, 100x100,  
200x100, 200x200



- Easy installation ideal for home, office and commercial applications
- Lightweight Aluminum Construction: provides a sleek, lighter, and elegant look
- 360° Rotary VESA Plate: for more viewing experience
- Integrated Bubble Level: assures alignment
- Swiveling Arm(s): offer(s) maximum viewing flexibility
- Slide-In Wall Plate: provides easy access for attachment and detachment
- Cable Management: keep everything organized



### Aluminum Full-Motion TV Wall Mount

[423755]

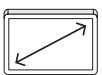

Screen Size  
23"-42"



Weight Capacity  
20 kg

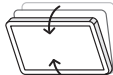

Tilt Range  
+15°~-15°

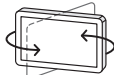

Swivel Range  
+90°~-90°

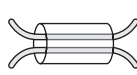

Cable  
Management

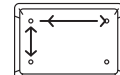

VESA Compatible  
100x100, 200x100, 200x200

# Full-motion TV Wall Mounts

Display arms with maximum flexibility for recommended screen sizes up to 55"



Shown: 461320

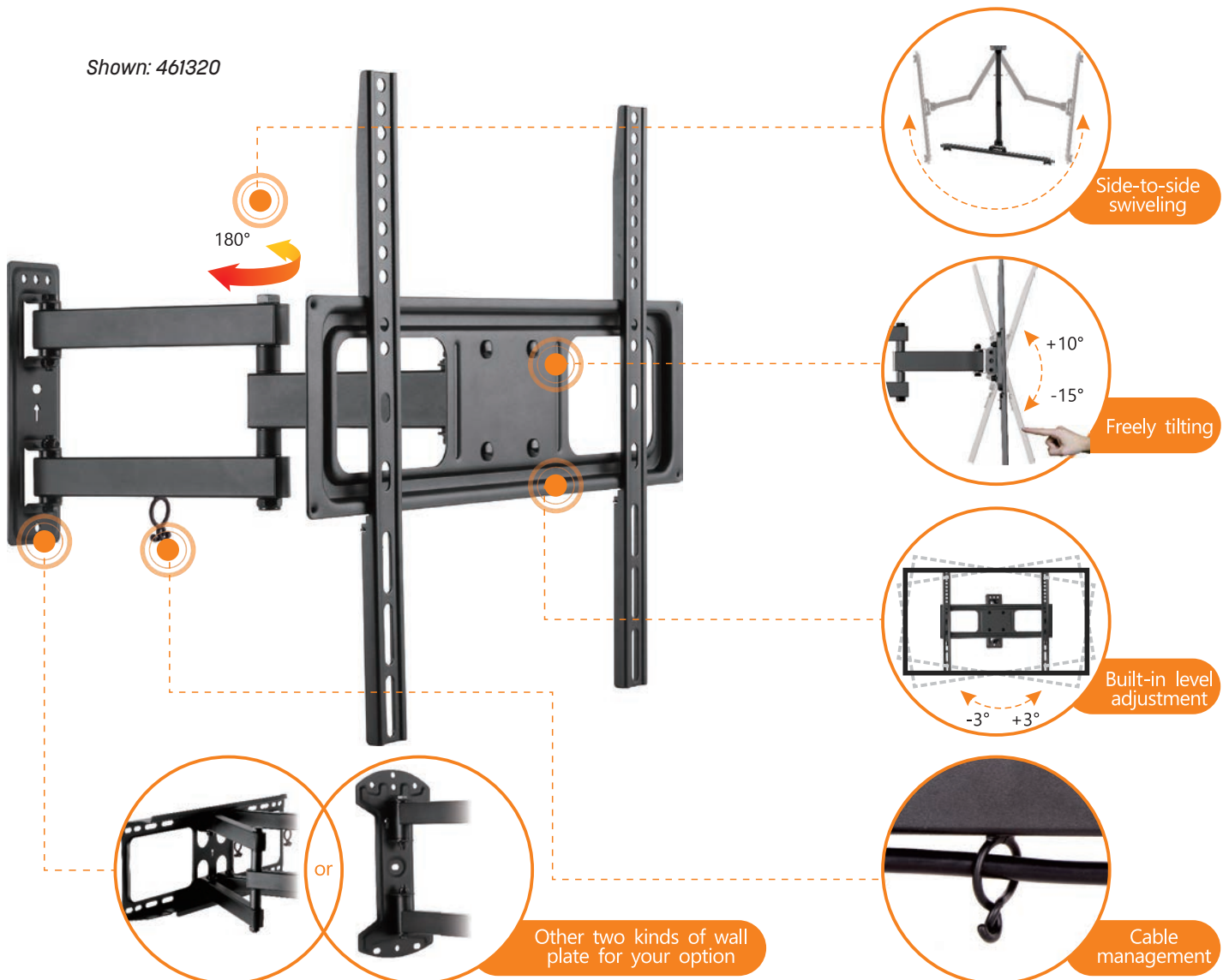

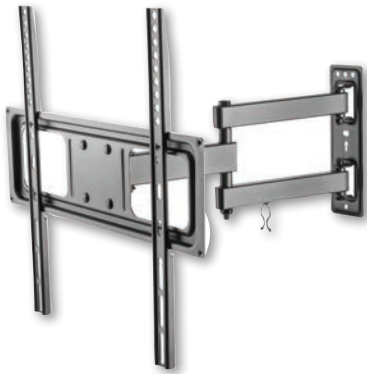

- Free-Tilting Design: makes easy forward or backward adjustment for better viewing and reduced glare
- Swiveling Arm(s): offer(s) maximum viewing flexibility
- Sturdy Steel Construction: provides a solid and long-lasting performance
- Built-In Level Adjustment: ensures perfect positioning
- Cable Management: keep everything organized

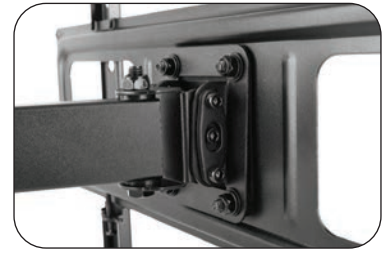

**Full-Motion TV Wall Mount**

[461320]

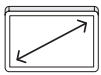

Screen Size  
32"-55"



Weight Capacity  
35 kg



Tilt Range  
+10°~-15°

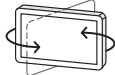

Swivel Range  
+90°~-90°



Screen Level  
+3°~-3°

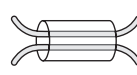

Cable Management

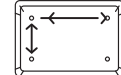

VESA Compatible  
200x200, 300x300,  
400x200, 400x400



- Free-Tilting Design: makes easy forward or backward adjustment for better viewing and reduced glare
- Swiveling Arm(s): offer(s) maximum viewing flexibility
- Sturdy Steel Construction: provides a solid and long-lasting performance
- Built-In Level Adjustment: ensures perfect positioning
- Cable Management: keep everything organized

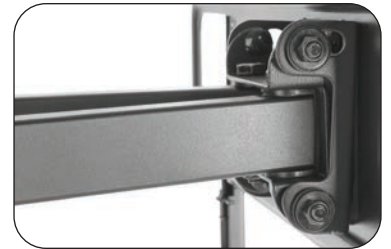

**Full-Motion TV Wall Mount**

[461344]

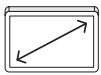

Screen Size  
32"-55"



Weight Capacity  
40 kg



Tilt Range  
+5°~-15°

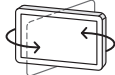

Swivel Range  
+60°~-60°



Screen Level  
+3°~-3°

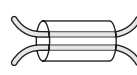

Cable Management

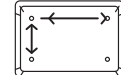

VESA Compatible  
200x200, 300x300,  
400x200, 400x400



- Free-Tilting Design: makes easy forward or backward adjustment for better viewing and reduced glare
- Swiveling Arm(s): offer(s) maximum viewing flexibility
- Sturdy Steel Construction: provides a solid and long-lasting performance
- Built-In Level Adjustment: ensures perfect positioning



**Full-Motion TV Wall Mount**

[461252]



Screen Size  
32"-55"



Weight Capacity  
50 kg



Tilt Range  
+10°~-20°

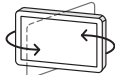

Swivel Range  
+90°~-90°



Screen Level  
+3°~-3°

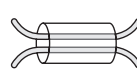

Cable Management

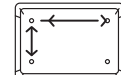

VESA Compatible  
200x200, 300x300,  
400x200, 400x400

# Aluminum Full-motion TV Wall Mount

Display arms with maximum flexibility for recommended screen sizes up to 55"



- Free-Tilting Design: makes easy forward or backward adjustment for better viewing and reduced glare
- Swiveling Arm(s): offer(s) maximum viewing flexibility
- Sturdy Steel Construction: provides a solid and long-lasting performance
- Built-In Level Adjustment: ensures perfect positioning



## Full-Motion TV Wall Mount

[461306]

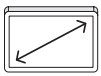

Screen Size  
32"-55"



Weight Capacity  
50 kg



Tilt Range  
+5°~-15°

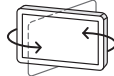

Swivel Range  
+60°~-60°



Screen Level  
+2.5°~-2.5°

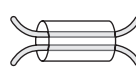

Cable Management

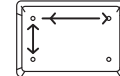

VESA Compatible  
200x200, 300x300,  
400x200, 400x400

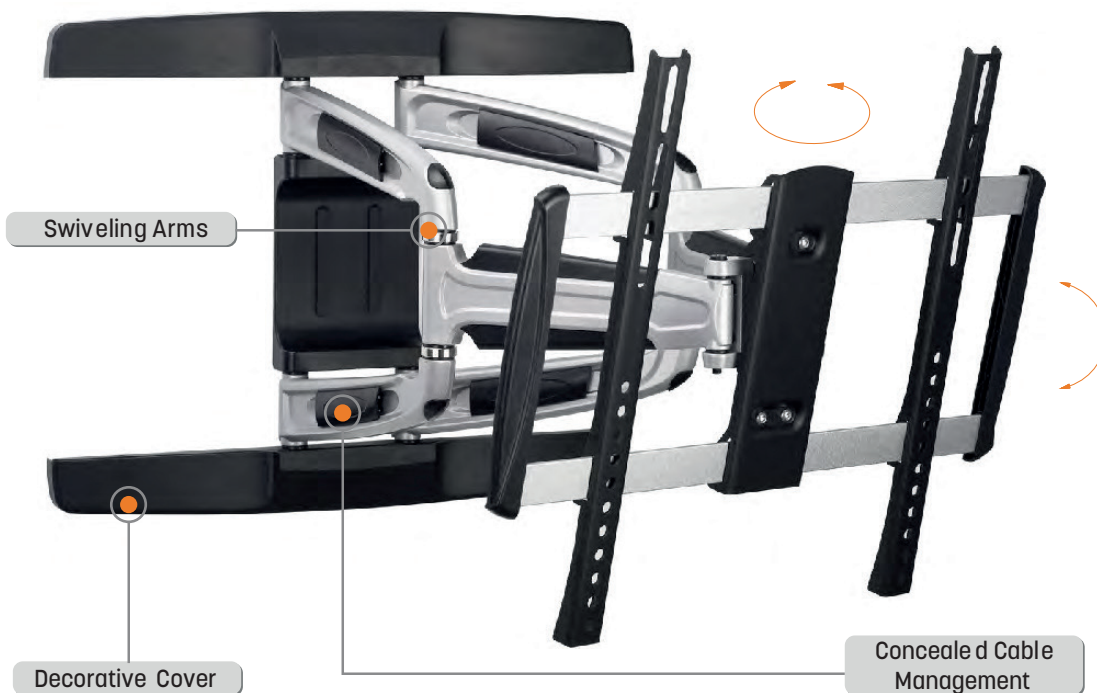



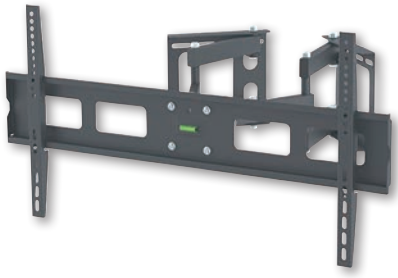

- Split Wall Plate: works on different angled corner walls and save space (also can be installed on flat wall)
- Swiveling Arm(s): offer(s) maximum viewing flexibility
- Built-In Level Adjustment: ensures perfect positioning
- Integrated Bubble Level: assures alignment
- Sturdy Steel Construction: provides a solid and long-lasting performance



### Corner Installation Full-Motion TV Wall Mount

[461214]

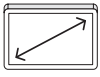

Screen Size  
37"-63"



Weight Capacity  
60 kg

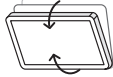

Tilt Range  
+15°~-15°

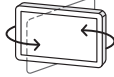

Swivel Range  
+120°~-120°



Screen Level  
+5°~-5°

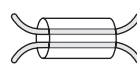

Cable Management

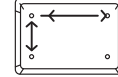

VESA Compatible  
200x200, 300x300, 400x200,  
400x400, 600x400, 800x400



- Free-Tilting Design: makes easy forward or backward adjustment for better viewing and reduced glare
- Swiveling Arm(s): offer(s) maximum viewing flexibility
- Built-In Level Adjustment: ensures perfect positioning
- Cable Management: keep everything organized
- Sturdy Steel Construction: provides a solid and long-lasting performance



### Full-Motion TV Wall Mount

[461337]

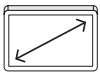

Screen Size  
37"-70"



Weight Capacity  
35 kg



Tilt Range  
+10°~-15°

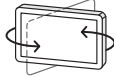

Swivel Range  
+90°~-90°



Screen Level  
+3°~-3°

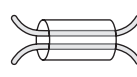

Cable Management

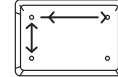

VESA Compatible  
200x200, 300x300,  
400x200, 400x400, 600x400



- Free-Tilting Design: makes easy forward or backward adjustment for better viewing and reduced glare
- Swiveling Arm(s): offer(s) maximum viewing flexibility
- Built-In Level Adjustment: ensures perfect positioning
- Cable Management: keep everything organized
- Sturdy Steel Construction: provides a solid and long-lasting performance

### Full-Motion TV Wall Mount

[461351]

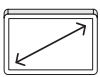

Screen Size  
37"-70"



Weight Capacity  
35 kg



Tilt Range  
+10°~-15°

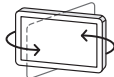

Swivel Range  
+90°~-90°

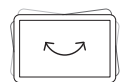

Screen Level  
+3°~-3°

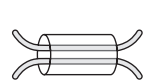

Cable Management

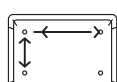

VESA Compatible  
200x200, 300x300,  
400x200, 400x400, 600x400

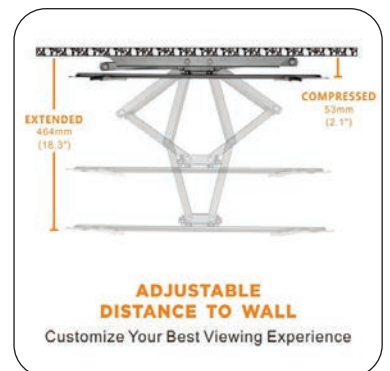
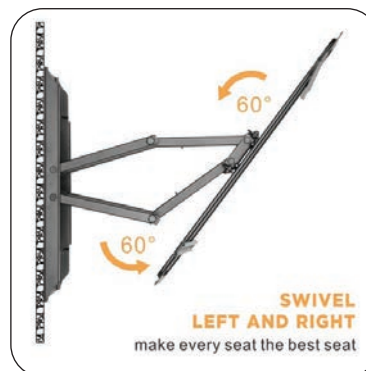



- Free-Tilting Design: makes easy forward or backward adjustment for better viewing and reduced glare
- Swiveling Arm(s): offer(s) maximum viewing flexibility
- Built-In Level Adjustment: ensures perfect positioning
- Sturdy Steel Construction: provides a solid and long-lasting performance

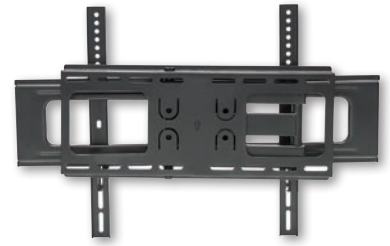

**Full-Motion TV Wall Mount**

[461283]

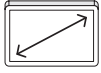

Screen Size  
37"-70"



Weight Capacity  
50 kg



Tilt Range  
+10°~ -20°

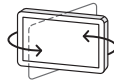

Swivel Range  
+90°~ -90°



Screen Level  
+3°~ -3°

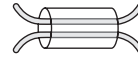

Cable Management

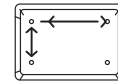

VESA Compatible  
200x200, 300x300,  
400x200, 400x400, 600x400

**Heavy-Duty Full-Motion TV Wall Mounts**

**Heavy-Duty Arms**  
firmly hold up to 80kg/176lbs



**Cable Management**  
for a clean post-install appearance

**Toolless Tilting**  
for optimal viewing angles

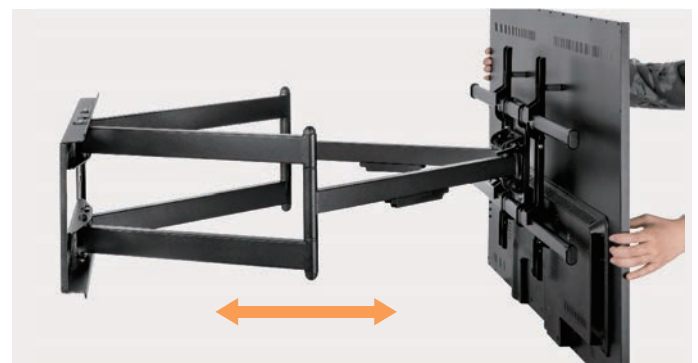
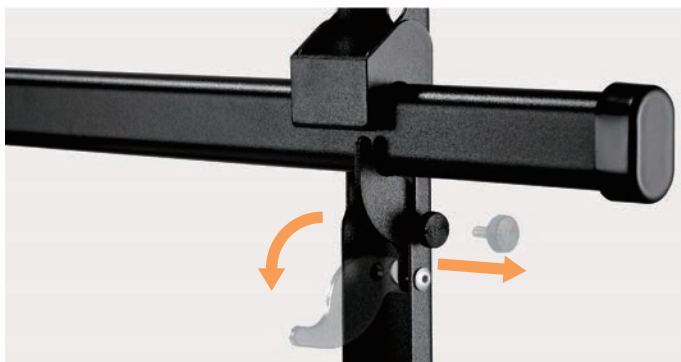

**Quick-Release Design**  
locks or releases the TV in a snap

**Smooth Moving**  
for a better positioning experience



## Heavy-Duty Full-Motion TV Wall Mounts

Designed for large TVs up to 100" and up to 80 kg, these sturdy heavy-duty steel arms are up to any challenge. For the perfect viewing angle, they extend up to 635 mm.



- Quick-Release Latch: locks/unlocks the display in place
- Swiveling Arm(s): offer(s) maximum viewing flexibility
- Free-Tilting Design: makes easy forward or backward adjustment for better viewing and reduced glare
- Sturdy Steel Construction: provides a solid and long-lasting performance
- Built-In Level Adjustment: ensures perfect positioning
- Cable Management: keep everything organized



### Heavy-Duty Full-Motion TV Wall Mount

[461290]



Screen Size  
37"-90"



Weight Capacity  
75 kg



Tilt Range  
+5°~-15°

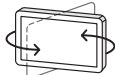

Swivel Range  
+60°~-60°



Screen Level  
+3°~-3°

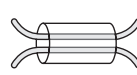

Cable Management

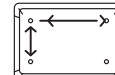

VESA Compatible  
200x200, 300x300, 400x200,  
400x400, 600x400, 800x400

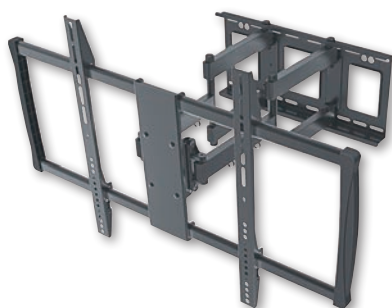

- Easy installation ideal for home, office and commercial applications
- Swiveling Arm(s): offer(s) maximum viewing flexibility
- Sturdy Steel Construction: provides a solid and long-lasting performance
- Built-In Level Adjustment: ensures perfect positioning
- Cable Management: keep everything organized
- Keyhole Pattern: allows for easy installation

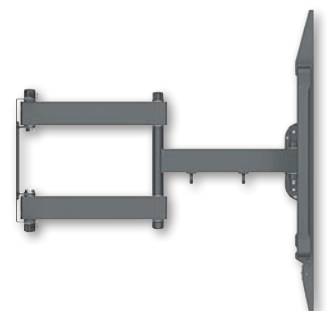

### Heavy-Duty Full-Motion TV Wall Mount

[461221]

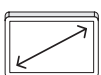

Screen Size  
60"-100"



Weight Capacity  
80 kg

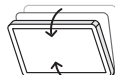

Tilt Range  
+5°~-15°

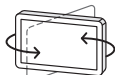

Swivel Range  
+45°~-45°



Screen Level  
+3°~-3°

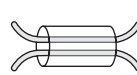

Cable Management

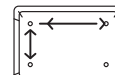

VESA Compatible  
200x200, 300x300, 400x200,  
400x400, 600x400, 800x400, 900 x600

# TV Ceiling Mounts

Height-adjustable, full-motion mounts for recommended screen sizes up to 70", for sloped and flat ceilings



## Full-Motion Telescopic TV Ceiling Mount [423625]

- Telescoping Height Adjustment: for the optimal viewing height
- Free-Tilting Design: makes easy forward or backward adjustment for better viewing and reduced glare
- 360° Rotation Around the Pole: provides optimal viewing
- Sturdy Steel Construction: provides a solid and long-lasting performance
- Cable Management: keep everything organized

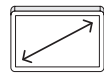
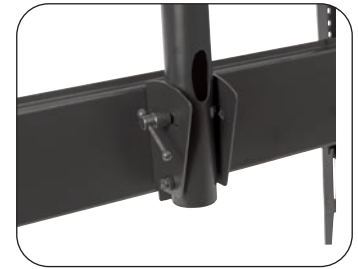

Screen Size  
37"-70"



Weight Capacity  
50 kg



Tilt Range  
0°~15°

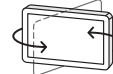

Swivel Range  
360°

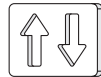

Height Adjustable  
1050-1560 mm



Anti-Theft

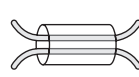

Cable Management

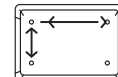

VESA Compatible  
200x200, 400x200, 300x300,  
400x400, 600x400, 800x400



NEW

## Full-Motion Telescopic TV Ceiling Mount [462204]

- Telescoping Height Adjustment: for the optimal viewing height
- Adjustable Ceiling Plate: for mounting in flat or sloping ceiling
- Free-Tilting Design: makes easy forward or backward adjustment for better viewing and reduced glare
- Sturdy Steel Construction: provides a solid and long-lasting performance
- Built-In Level Adjustment: ensures perfect positioning
- Cable Management: keep everything organized



For sloped and flat ceilings

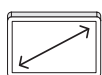

Screen Size  
37"-70"



Weight Capacity  
50 kg



Tilt Range  
0°~15°

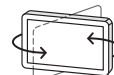

Swivel Range  
360°

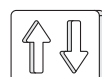

Height Adjustable  
1050-1560 mm

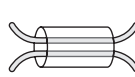

Cable Management

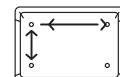

VESA Compatible  
200x200, 300x300,  
400x200, 400x400, 600x400





### Portable Tripod Stand for Monitors, Projectors and Laptops [461788]

- Non-Skid Rubber Pads: protect work surface from scratches or scuffs
- Easy-Grip Knobs: for quick tilt and lock
- Locking Rotary Knob: ensures toolless height adjustment
- Safety Ledge Stopper: prevents your devices from slipping
- Height Adjustment: satisfies user's different preference
- Sturdy Steel Construction: provides a solid and long-lasting performance

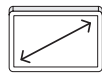

Screen Size  
13"-32"



Weight Capacity  
15 kg



Tilt Range  
0°~90°

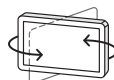

Swivel Range  
+180°~-180°



Height Adjustable  
1080-1780 mm

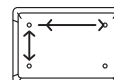

VESA Compatible  
75x75, 100x100



**1 Laptop Workstation**

**2 Projector Stand**

**3 Monitor Mount**

Fits 13"-32" monitors

100x100 Max. VESA

Versatile Mounting Options



### Portable Tripod TV Mount Stand [461412]

- Easy-Grip Knobs: for quick tilt and lock
- Security Pin: firmly secures TV at desired height for enhanced safety
- 5 Height Settings: for optimal viewing height
- Sturdy Steel Construction: provides a solid and long-lasting performance

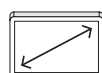

Screen Size  
37"-70"



Weight Capacity  
35 kg



Tilt Range  
0°~8°



Height Adjustable  
1240-1880 mm

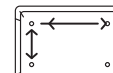

VESA Compatible  
200x200, 400x200,  
300x300, 400x400, 600x400

Portable TV Mount Tripod Stand

[461795]

**NEW**



To prevent TV tip-over and ensure the children's safety, an anti-fall wire rope is included to secure the TV.

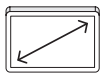

Screen Size  
37"-70"



Weight Capacity  
50 kg

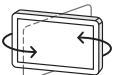

Swivel Range  
+180°~-180°

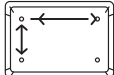

VESA Compatible  
200x200, 300x200, 300x300,  
400x200, 400x300, 400x400,  
600x400

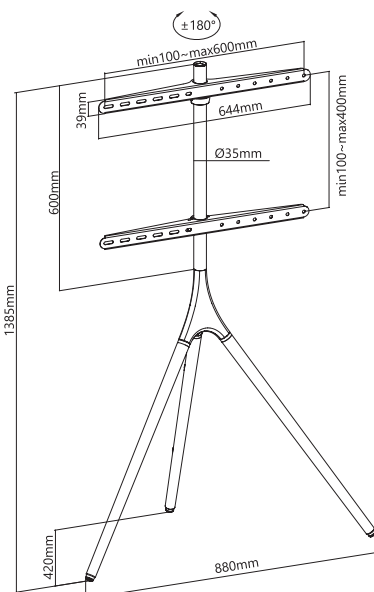

**Solid Wood**



**Easy Locking Design**  
makes TV installation a snap

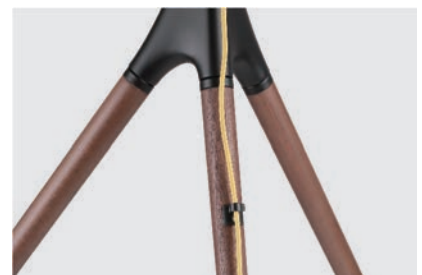

**Sleek Cable Management**  
for a clean and neat look



**Non-Slip Protective Feet Pad**  
for increased security and safety

**Ultra Slim TV Floor Standing Mount**

[462044]

**NEW**

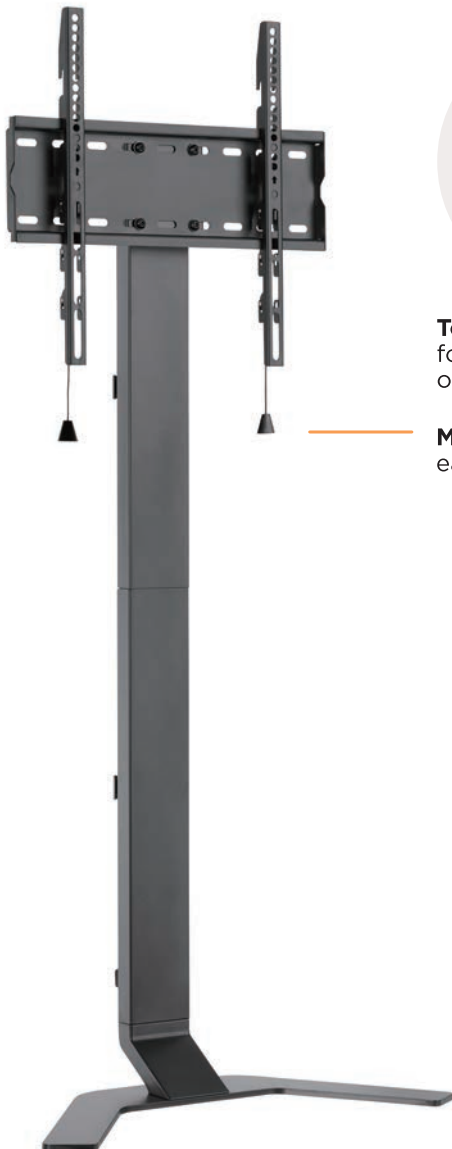

**Toolless Tilting**  
for effortless positioning and optimal viewing experience

**Magnetic Pull Straps**  
easy to hide when not used

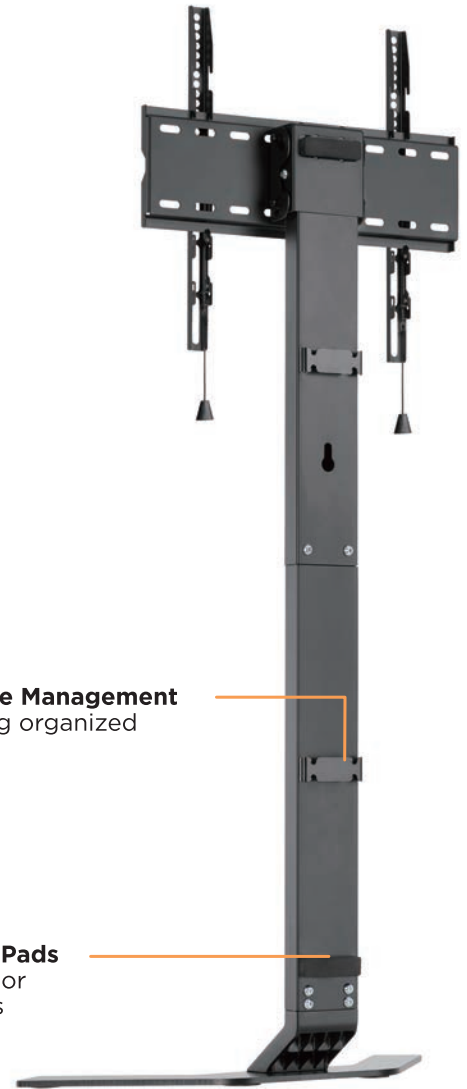

**Integrated Cable Management**  
keeps everything organized

**Soft EVA Foam Pads**  
avoid scratches or damage to walls

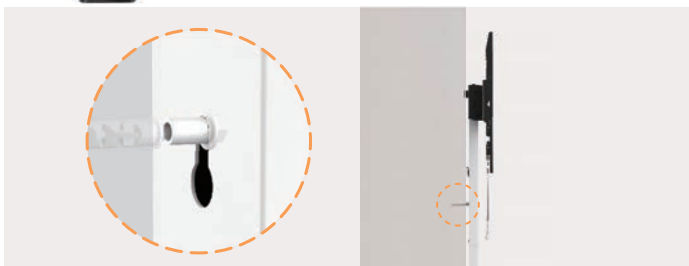

**Safety Kits Included**

attach the stand to the wall to prevent accidental tipping



**Angled Design**

fits over baseboards while providing increased stability

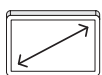

Screen Size  
32"-70"



Weight Capacity  
40 kg



Tilt Range  
+3°~-10°

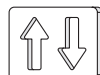

Height Adjustable  
1057, 1115 & 1173 mm



Spring  
Lock

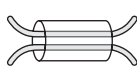

Cable  
Management

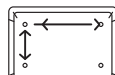

VESA Compatible  
200x200, 300x200, 300x300,  
400x200, 400x300, 400x400

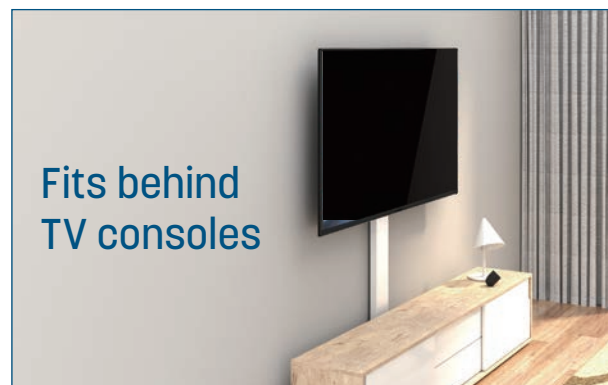

**Fits behind  
TV consoles**

# Carts

For displays, projectors, laptops and audio/video accessories

**NEW**



## Cart/Trolley for Projectors and Laptops

[461726]



Weight Capacity  
10 kg per tray

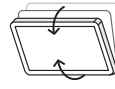

Tilt Range  
+35°~-35°

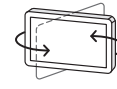

Swivel Range  
360°

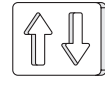

Height Adjustable  
700-1100 mm

- Adjustable cart/trolley with two trays for projectors and notebooks
- Heavy-Duty Casters with Locking Mechanism: can be moved or stopped at will
- Height Adjustment: satisfies user's different preference
- Integrated tool-free thumbscrews for safe, convenient tilt and height adjustment



**Ideal for presentations, meetings or trainings in conference rooms, schools, universities, hotels and more**



**Economy Height-Adjustable Multimedia TV Cart**  
[461238]

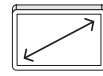

Screen Size  
37"-70"



Weight Capacity  
40 kg



Tilt Range  
+10°~-10°

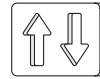

Height Adjustable  
1290, 1370 or 1450 mm

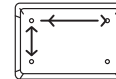

VESA Compatible  
200x200, 400x200,  
300x300, 400x400, 600x400

- Height adjustable TV mount
- Heavy-Duty Casters: offer smooth mobility with quality that lasts a lifetime
- Height Adjustable Equipment Shelf: provides more storage space for accessories
- Free-Tilting Design: makes easy forward or backward adjustment for better viewing and reduced glare
- Delivery-friendly retractable design
- Height adjustable camera shelf
- Sturdy Steel Construction: provides a solid and long-lasting performance



## Aluminum Height-Adjustable Multimedia TV Cart [461245]

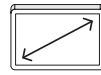

Screen Size  
37"-70"



Weight Capacity  
50 kg



Tilt Range  
+5°~-12°



Height Adjustable  
1200-1600 mm

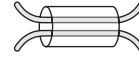

Cable  
Management

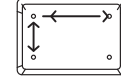

VESA Compatible  
200x200, 400x200,  
300x300, 400x400, 600x400



- Height adjustable TV mount
- Quick-Release Spring Lock: adjusts height effortlessly
- Lightweight Aluminum Construction: provides a sleek, lighter, and elegant look
- Cable Management: keep everything organized
- Free-Tilting Design: makes easy forward or backward adjustment for better viewing and reduced glare
- Quick Assembly Shelf: assures easy post-installation and height adjustable
- Heavy-Duty Casters: offer smooth mobility with quality that lasts a lifetime



## Ultra Heavy-Duty Height-Adjustable TV Cart

[461665]

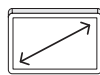

Screen Size  
37"-100"



Weight Capacity  
150 kg



Tilt Range  
+5°~-12°

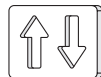

Height Adjustable  
1380 or 1530 mm

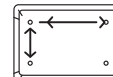

VESA Compatible  
200x200, 300x200, 300x300, 400x200,  
400x300, 400x400, 600x400, 800x400, 800x600



- Height adjustable TV mount
- Quick-Release Spring Lock: adjusts height effortlessly
- Cable Management: keep everything organized
- Free-Tilting Design: makes easy forward or backward adjustment for better viewing and reduced glare
- Sturdy Steel Construction: provides a solid and long-lasting performance

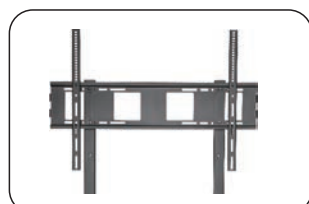

## Aluminum Heavy-Duty Height-Adjustable Multimedia TV Cart [461672]

**NEW**

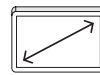

Screen Size  
60"-100"



Weight Capacity  
100 kg



Tilt Range  
+5°~-10°

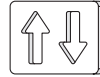

Height Adjustable  
1200 or 1685 mm

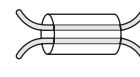

Cable  
Management

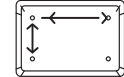

VESA Compatible  
400x400, 600x400,  
800x400, 800x600, 1000x600

- Height Adjustment: for proper positioning
- Cable Management: keep everything organized
- Lightweight Aluminum Construction: provides a sleek, lighter, and elegant look
- Sturdy steel base
- Column Height Markings: conveniently displays the current height
- Height adjustable TV mount
- Quick Assembly Shelf: assures easy post-installation and height adjustable





# Projector Mounts

For ceiling and wall

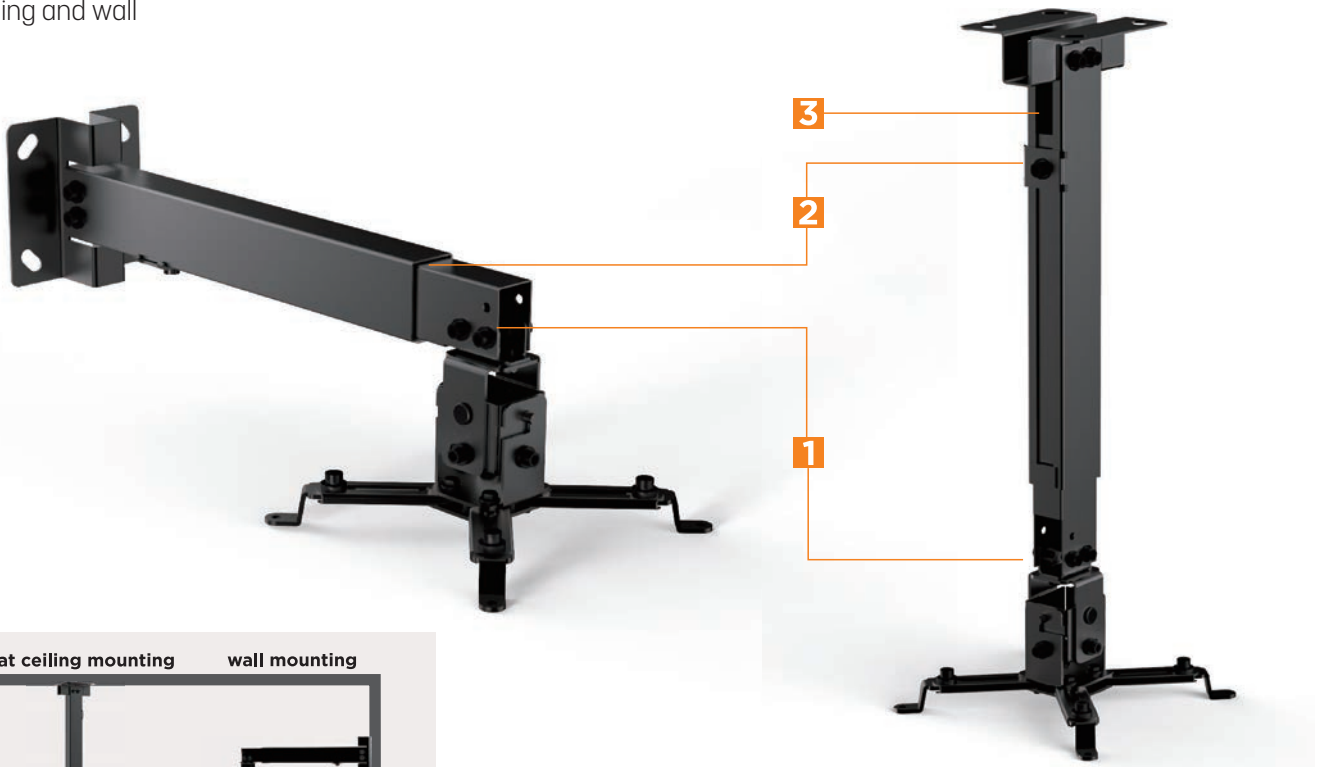

## Projector Wall or Ceiling Mount

[461207]

### Features

- 1** Angle adjustment fits wall and ceiling.
- 2** Adjustable height for your different choices.
- 3** Integrated cable management system conceals and protects cables.
- 4** Loading capacity up to 20kg for most projectors.

Weight Capacity  
20 kg

Mounting Range  
Ø 225-316 mm

Tilt Range  
+15°~-15°

Swivel Range  
+8°~-8°

Height-Adjustable  
430-650 mm



## Projector Ceiling Mount

[461184]

- 360° Rotating Joint: for optimal viewing angles
- Swiveling Joint: offers maximum viewing flexibility
- Adjustable Support Arms: fit most projectors with ease
- Cable Management: keep everything organized
- Sturdy Steel Construction: provides a solid and long-lasting performance

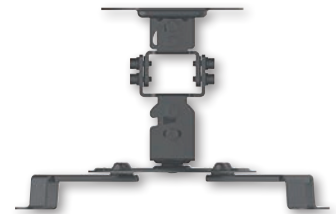

Weight Capacity  
13.5 kg

Mounting Range  
Ø 54-320 mm

Tilt Range  
+15°~-15°

Swivel Range  
+15°~-15°

Height-Adjustable  
150 mm



- 360° Rotating Joint: for optimal viewing angles
- Swiveling Joint: offers maximum viewing flexibility
- Height Adjustment: for proper positioning
- Adjustable Support Arms: fit most projectors with ease
- Cable Management: keep everything organized
- Lightweight Aluminum Construction: provides a sleek, lighter, and elegant look

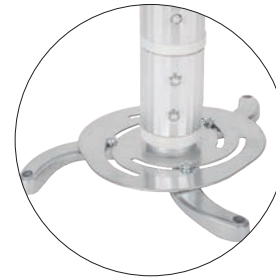

### Aluminum Projector Ceiling Mount

[424820]

Weight Capacity 10 kg	Mounting Range Ø 130-320 mm	Tilt Range +10°~-10°	Swivel Range 360°	Height-Adjustable 130-1060 mm



- 360° Rotating Joint: for optimal viewing angles
- Swiveling Joint: offers maximum viewing flexibility
- Height Adjustment: for proper positioning
- Adjustable Support Arms: fit most projectors with ease
- Sturdy Steel Construction: provides a solid and long-lasting performance



### Projector Ceiling Mount

[424868]

Weight Capacity 15 kg	Mounting Range Ø 130-320 mm	Tilt Range +180°~-180°	Swivel Range 360°	Height-Adjustable 1220-2020 mm



- 360° Rotating Joint: for optimal viewing angles
- Swiveling Joint: offers maximum viewing flexibility
- Height Adjustment: for proper positioning
- Adjustable Support Arms: fit most projectors with ease
- Cable Management: keep everything organized
- Lightweight Aluminum Construction: provides a sleek, lighter, and elegant look

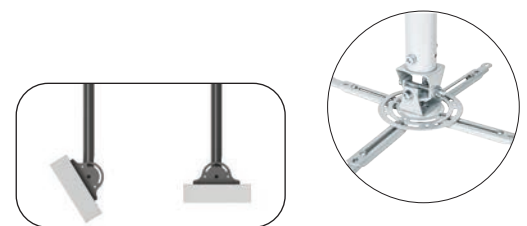

For sloped and flat ceilings

### Aluminum Projector Ceiling Mount

[424851]

Weight Capacity 20 kg	Mounting Range Ø 130-320 mm	Tilt Range +20°~-20°	Swivel Range 360°	Height-Adjustable 575-825 mm



NEW

### Wall Mount for Streaming Boxes and Media Players

**[462075]** Holds a Streaming Device (Apple TV®, Roku®, Xiaomi® or Raspberry Pi® and More) up to 5 kg (11 lbs.), Extendable 47 - 76 mm (1.85 - 2.99 in.), Steel, Black

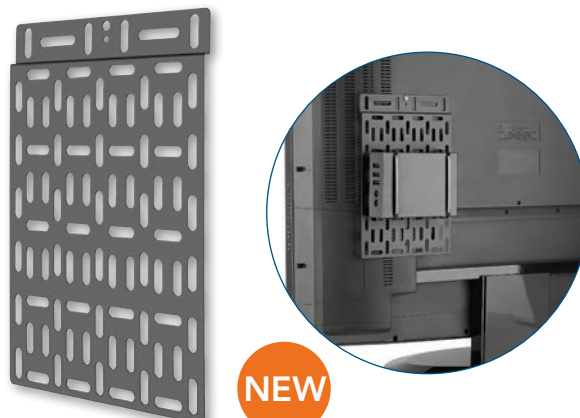

NEW

### Mounting Bracket for Streaming Boxes and Media Players

**[462082]** Hides a Streaming Device (Apple TV®, Roku®, Xiaomi® or Raspberry Pi® and More) up to 5 kg (11 lbs.) Behind Your TV, Attaches to TV/TV Mount/Wall, Steel, Black



NEW

### Adjustable Stand for Laptops and Tablets

**[462129]** Ergonomic Riser for Notebooks and Other Devices from 10" to 15.6" and up to 5 kg (11 lbs.), Foldable in Five Positions, Black



NEW

### Adjustable VESA Mount Laptop Holder

**[462211]** Tray for One 11" to 17" Notebook up to 4 kg (8.8 lbs.), Attaches to Monitor Mount with VESA Standards 75x75 and 100x100, Black



NEW

### Secure Wall Mount Holder for Tablet and iPad

**[462105]** Black

**[462228]** White

Anti-theft Kiosk for Tablets from 9.7" to 10.5", Mountable on Wall or VESA Plate, Black



NEW

### Lockable Desk Stand and Wall Mount Holder for Tablet and iPad

**[462112]** Secure Anti-theft Kiosk for Tablets from 7.9" to 10.5", 360° Rotation, +/-70° Tilt, 330° Swivel, Lock with Two Keys, Black

# For Mobile Devices in Hospitality, Education & More

From students to customers and guests to employees, we all enjoy a fully charged device and a secure place to store it. A Manhattan Charging Cabinet gives you the upper hand in education and hospitality with a lockable space to keep phones, tablets, Chromebooks and laptops ready to go. If you also want to disinfect your devices, choose a model with UV LEDs that eliminate 99.99% of germs, viruses and bacteria without any heat, liquids or chemicals.



Offices



Schools



Restaurants

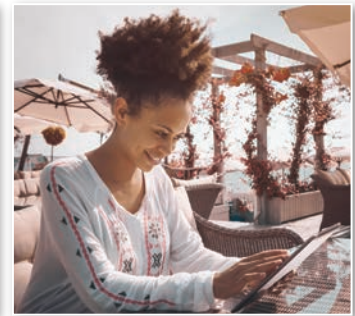

Hotels



Doctor's Offices

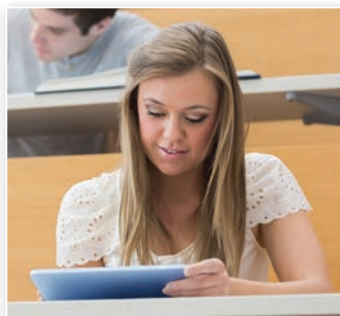

Universities



Gyms



Bars & Cafés

					UV disinfection		UV disinfection	
Model#	715942	715959	716000	102353	180351	180535	180542	180658
Device bays	10	20	32	32	16	10	32	32
Suitable devices	Smartphones & tablets up to 10"	Smartphones & tablets up to 10"	Smartphones & tablets up to 12"	Chromebooks, smartphones & tablets up to 15.6"	Laptops, tablets & smartphones up to 15.6"	Laptops, tablets & smartphones up to 15.6"	Laptops, tablets & smartphones up to 15.6"	Laptops, tablets & smartphones up to 15.6"
Charging ports	10 USB-C ports	20 USB-C ports	32 USB-C ports + 1 USB-A port + 2 AC outlets	32 USB-C ports	16 USB-C ports	10 UK AC outlets (other versions available on request)	32 UK AC outlets (other versions available on request)	32 USB-A ports + 32 AC outlets
Output power per USB port	18 W	18 W	18 W	18 W	65 W	-	-	2.4 A / 5 V
USB-C Power Delivery	Yes	Yes	Yes	Yes	Yes	-	-	-
UV disinfection	-	-	-	-	Yes	-	-	Yes
Built-in cable management	Yes	Yes	Yes	Yes	Yes	Yes	Yes	Yes
Reversible door	-	-	-	-	Yes	Yes	Yes	Yes
Lock	Key	Key	Pin code	Key	Key	Key	Key	Key
Power input	IEC320 C20	IEC320 C20	IEC320 C20	IEC320 C14	IEC320 C14	IEC320 C14	IEC320 C14	IEC320 C14
Wall-mountable	-	-	-	-	Yes	Yes	-	-
Stackable	-	-	-	-	Yes	Yes	-	-
Mobility	Stationary	Stationary	Casters	Casters	Optional casters & handle included	Stationary	Casters	Casters
External unit dimensions	370 (D) x 360 (W) x 345 (H) mm	370 (D) x 610 (W) x 345 (H) mm	460 (D) x 633 (W) x 575 (H) mm	633 (D) x 633 (W) x 1013 (H) mm	471 (D) x 633 (W) x 463 (H) mm	437 (D) x 460 (W) x 485 (H) mm	645 (D) x 642 (W) x 697 (H) mm	577 (D) x 645 (W) x 1029 (H) mm
Weight	15 kg	18 kg	45 kg	57 kg	31 kg	15 kg	55 kg	73 kg



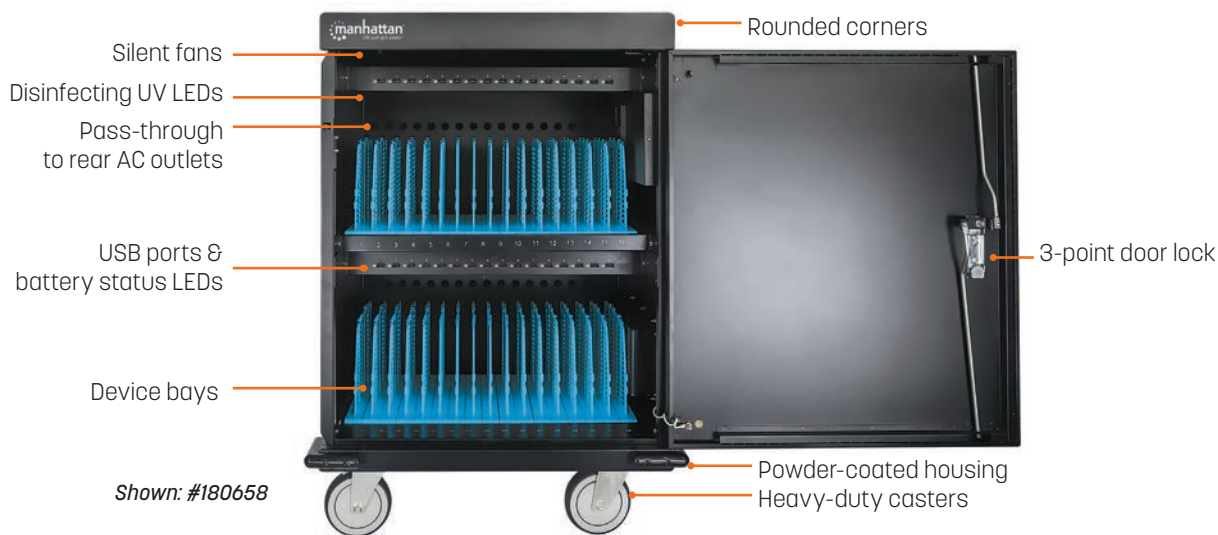

**NEW**

**UVC High-Power Charging Cabinet with 16 USB-C Ports - 1040 W**

**[180351]** 16 USB-C PD Ports with Power per Port up to 65 W, Spacious Bays for Laptops, Phones & Tablets, 1040 W Total, Disinfecting UVC LEDs, Lockable, Surge Protection

- Integrated UV LEDs to eliminate 99.99% of germs, viruses and bacteria
- Stackable up to two units for more charging ports



Safely stores, fast-charges and disinfects up to 16 smartphones, tablets and notebooks up to 15.6"

USB-C Power Delivery (PD 3.0) charging ports with power per port up to 65 W; no additional wall chargers required. USB-C charging cables available on page 80-82

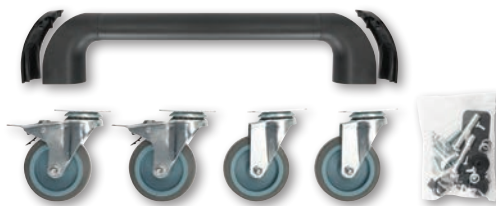

Wall-mount option saves space and prevents theft.

Optional included handle and four heavy-duty wheels turn it into a charging cart.



**10-Port Desktop Charging Cabinet - 180 W**

[715942] 10 USB-C PD Ports, Bays for Phones & Tablets up to 10", 180 W Total, up to 18 W per Port, Lockable, Surge Protection, Silent Ventilation, Metal Housing

- Sturdy, secure, powder-coated metal housing; lockable with two included keys



**20-Port Desktop Charging Cabinet - 360 W**

[715959] 20 USB-C PD Ports, Bays for Phones & Tablets up to 10", 360 W Total, up to 18 W per Port, Lockable Split Door, Surge Protection, Silent Ventilation, Metal Housing

- Sturdy, secure, powder-coated metal housing; lockable with two included keys
- Vertically split double-door ideal for confined spaces



**32-Port Charging Cart - 576 W**

[716000] 32 USB-C PD Ports, Bays for Phones & Tablets up to 12", 576 W Total, up to 18 W per Port, Pin-Code Lock, Surge Protection, Silent Ventilation, Metal Housing

- Sturdy, secure, powder-coated metal housing; lockable with a pin code
- One additional 2.1 A / 5 V USB-A port and two EU CEE 7/3 outlets on the back for external charging
- Sturdy, stainless handle and four wheels, two with brakes



**32-Port Charging Cart - 576 W**

[102353] 32 USB-C PD Ports, Bays for Chromebooks, Tablets & Phones up to 15.6", 576 W Total, up to 18 W per Port, Surge Protection, Silent Ventilation, Metal Housing

- Sturdy, secure, powder-coated metal housing; 3-point door lock on front and back; two included keys
- Sturdy, stainless handle and four wheels



NEW

### 10-Port AC Charging Cabinet

**[180535]** 10 AC Outlets, Spacious Bays for Devices up to 15.6", Lockable, Wall-Mountable, Stackable

- AC outlets (10 total) in PDUs mounted in the top compartment
- Stackable up to two units for more charging ports
- Built-in wall-mounting holes on the back to install the cabinet, save space and prevent theft



NEW

### 32-Port AC Charging Cart

**[180542]** 32 Built-in Rear AC Outlets, Spacious Bays for Devices up to 15.6", Lockable, Surge Protection

- Built-in AC outlets (32 total) on the back
- Built-in handle and four heavy-duty wheels

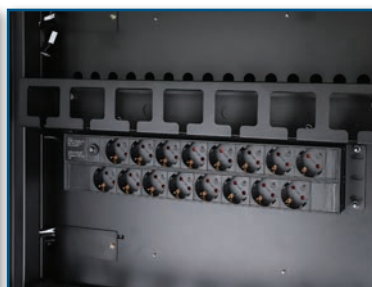

NEW

### UVC Charging Cart with 32 USB-A Ports and 32 AC Outlets

**[180658]** Power Management System USB-A Ports with Power per Port up to 2.4 A / 5 V, AC Outlets in Rear-Mount PDUs, Disinfecting UVC LEDs, Spacious Device Bays, Lockable, Surge Protection, Black

- USB-A charging ports (32 total) with power up to 2.4 A / 5 V per port on the front
- AC outlets (32 total) in PDUs mounted on the back
- High-tech Power Management System that prevents overload at anytime
- Integrated UV LEDs to eliminate 99.99% of germs, viruses and bacteria
- Sturdy, stainless handle and four heavy-duty wheels





Take back your outlets. Charge direct.

USB Charging Solutions for Smartphones, Tablets and more.



**2-Port USB-A Wall Outlet with Faceplate**

- Two USB-A ports
- 5 V / 2.1 A charging output
- Format 80 x 80 mm

[\[772181\]](#)



**2-Port USB-A Wall Outlet with Faceplate**

- Two USB-A ports
- 5 V / 2.1 A charging output
- Format 80 x 80 mm
- Dust cover

[\[772211\]](#)



**2-Port USB-A & USB-C Wall Outlet with Faceplate**

- One USB-A, one USB-C port
- 5 V / 2.1 A charging output
- Format 80 x 80 mm

[\[772198\]](#)



**2-Port USB-A & USB-C Wall Outlet with Faceplate**

- One USB-A, one USB-C port
- 5 V / 2.1 A charging output
- Format 80 x 80 mm
- Dust cover

[\[772228\]](#)



**2-Port USB-C Wall Outlet with Faceplate**

- Two USB-C ports
- 5 V / 2.1 A charging output
- Format 80 x 80 mm

[\[772204\]](#)



**2-Port USB-C Wall Outlet with Faceplate**

- Two USB-C ports
- 5 V / 2.1 A charging output
- Format 80 x 80 mm
- Dust cover

[\[772235\]](#)



**2-Port USB-A Wall Outlet & CEE 7/3 Socket with Faceplate**

- Two USB-A ports
- 5 V / 2.4 A charging output
- Format 80 x 80 mm

[\[772174\]](#)



**USB Charging Keystone Jack**

- One USB-A port
- 5 V / 1 A charging output
- Format 80 x 80 mm
- Designed to fit in wall plates or patch panels

[\[772167\]](#)



# Do you need products for the B2C channel? Ask for our separate catalog "Reseller Technology Essentials 2022"

Now Featuring:  
**New Sustainable and Eco-Friendly Cardboard Packaging**



To contribute our fair share to environment protection, we have shifted all our blister packaging to sustainable and eco-friendly cardboard, marked with the PAP21 icon.



This packaging is great for retail with small footprint, clean, attractive look, clear depiction of key features, and easy-to-understand graphics for unassisted sales.







[intellinetnetwork.eu](http://intellinetnetwork.eu)

  [intellinetnetwork.com/YT](https://www.youtube.com/intellinetnetwork)  
[intellinetnetwork.com/FB](https://www.facebook.com/intellinetnetwork)



[manhattanproducts.eu](http://manhattanproducts.eu)

   [manhattanproducts.com/YT](https://www.youtube.com/manhattanproducts)  
[manhattanproducts.com/FB](https://www.facebook.com/manhattanproducts)  
[manhattanproducts.com/IG](https://www.instagram.com/manhattanproducts)

## Featuring: **19" Smart 8-Port PDU**



19" Rackmountable Intelligent Power Distribution Unit; Monitors Power, Temperature and Humidity  
Learn more on page 21